

# Matanuska-Susitna Borough

Public Works Department



## Subdivision Construction Manual 2020

- Roads
- Drainage
- Utilities

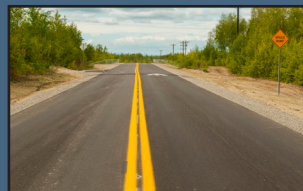
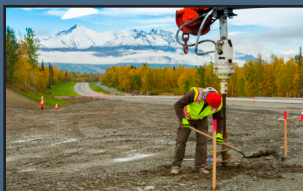

Adopted August 18, 2020  
**EFFECTIVE JANUARY 1, 2021**



CODE ORDINANCE

Sponsored by: Borough Manager  
Introduced: 08/04/20  
Public Hearing: 08/18/20  
Adopted: 08/18/20

**MATANUSKA-SUSITNA BOROUGH  
ORDINANCE SERIAL NO. 20-015**

AN ORDINANCE OF THE MATANUSKA-SUSITNA BOROUGH ASSEMBLY AMENDING MSB 43.05.015 PURPOSE AND SCOPE, TO REFERENCE THE 2020 SUBDIVISION CONSTRUCTION MANUAL

---

BE IT ENACTED:

Section 1. Classification. This ordinance is of a general and permanent nature and shall become a part of the Borough Code.

Section 2. Amendment of section. MSB 43.05.015(B)(3) is hereby amended to read as follows:

(3) **2020** Subdivision Construction Manual.

Section 3. Effective date. This ordinance shall take effect on January 1, 2021.

ADOPTED by the Matanuska-Susitna Borough Assembly this 18 day of August, 2020.

  
\_\_\_\_\_  
VERN HALTER, Borough Mayor

ATTEST:

  
\_\_\_\_\_  
LONNIE R. McKECHNIE, CMC, Borough Clerk

(SEAL)

PASSED UNANIMOUSLY: Hale, Nowers, Leonard, Mayfield, Sumner, and Boeve



## Table of Contents

Acronyms .....	iv
Definitions .....	v
Introduction .....	viii
Section A. Street Design .....	1
<b>A01</b> General .....	1
<b>A02</b> Applicability .....	1
<b>A03</b> Street Classifications .....	1
<b>A04</b> Access Criteria .....	3
<b>A05</b> Design Criteria .....	5
<b>A06</b> Typical Section .....	8
<b>A07</b> Turnarounds .....	8
<b>A08</b> Stub Streets .....	10
<b>A09</b> Intersections .....	10
<b>A10</b> Driveways .....	13
<b>A11</b> Trailhead .....	13
<b>A12</b> Bicycle and Pedestrian Paths .....	13
<b>A13</b> Signage .....	13
<b>A14</b> Railroad Crossings .....	15
<b>A15</b> Average Daily Traffic .....	16
<b>A16</b> Design Deviations .....	16
Section B. Major Road Corridors .....	17
<b>B01</b> General .....	17
<b>B02</b> Right-of-way and Surface Widths .....	17
<b>B03</b> Frontage, Backage, and Connector Street Standards .....	17
<b>B04</b> Access Standards .....	18
<b>B05</b> Future Corridors .....	19
<b>B06</b> References .....	19
Section C. Construction Requirements .....	20
<b>C01</b> General .....	20
<b>C02</b> Road Construction .....	20
<b>C03</b> Roads Outside of a Road Service Area .....	21
<b>C04</b> Pioneer Road Construction Requirements .....	22
<b>C05</b> Winter Construction .....	23
<b>C06</b> Alternate Methods and Materials .....	23
<b>C07</b> Materials .....	23
Section D. Drainage .....	26
<b>D01</b> General .....	26
<b>D02</b> Requirements .....	26

<b>D03</b>	Drainage Design Criteria .....	27
<b>D04</b>	Drainage Ditches .....	29
<b>D05</b>	Culverts .....	29
<b>D06</b>	Fish Passage Culverts .....	30
<b>D07</b>	Rainfall Data .....	33
Section E.	Easements .....	35
<b>E01</b>	General .....	35
Section F.	Development Implementation .....	37
<b>F01</b>	General .....	37
Section G.	Commercial and Industrial Subdivisions .....	41
<b>G01</b>	General .....	41
Section H.	Utilities .....	42
<b>H01</b>	General .....	42
<b>H02</b>	Utility Location Guidelines .....	42
References	.....	44
Appendix A	.....	55
Appendix B	.....	67

## Figures

Figure A-1: Loop Residential Streets.....	3
Figure A-2: Loop Residential Subcollector Streets.....	4
Figure A-3: Typical Section.....	8
Figure A-4: Cul-de-sac Options .....	9
Figure A-5: Alternate Turnarounds.....	9
Figure A-6: Intersection Sight Distance.....	11
Figure A-7: Intersection Offset .....	12
Figure A-8: Intersection Angle .....	12
Figure A-9: Controlled Street Landing Profile.....	13
Figure A-10: Sign Placement .....	14
Figure A-11: Stop Sign Location .....	15
Figure A-12: Concrete Foundation for Sign Post .....	15
Figure B-1: Frontage Street Configurations .....	18
Figure C-1: Structural Sections for Gravel Roads.....	24
Figure C-2: Structural Sections for Paved Roads .....	25
Figure D-1: Intensity-Duration-Frequency Relationships for the Matanuska-Susitna Borough ..	33

## Tables

Table A-1: Design Criteria .....	6
Table A-2: Recommended and Minimum Intersection Sight Distance .....	11
Table B-1: Average Access Point Spacing.....	19
Table C-1: Aggregate Quality Properties for Base Course .....	24
Table C-2: Aggregate Gradations.....	24
Table D-1: Drainage Sizing and Analysis Criteria .....	28
Table D-2: Recurrence Interval Hyetographs (in/hr) for the Matanuska-Susitna Borough .....	34

## Acronyms

AASHTO	American Association of State Highway and Transportation Officials
ADFG	Alaska Department of Fish and Game
ADT	Average Daily Traffic
ADOT&PF	Alaska Department of Transportation and Public Facilities
ATM	Alaska Test Method
DPW	Department of Public Works of the Matanuska-Susitna Borough
IFC	International Fire Code
ITE	Institute of Transportation Engineers
L RTP	Long Range Transportation Plan
MSB	Matanuska-Susitna Borough
N/A	Not applicable
NTP	Notice to proceed
OHWM	Ordinary high water mark
OSHP	Official Streets and Highways Plan
PUE	Public use easement
ROW	Right-of-way
VPD	Vehicles per day



## Definitions

<b>Access Point</b>	The location along a road at which a driveway or road intersects.
<b>Arterial</b>	A road that provides a high level of mobility within the transportation network. Arterials have managed access with a minimal number of intersections or interchanges.
<b>Average Daily Traffic</b>	The total number of vehicle trips during a given time period (in whole days greater than one day and less than one year) divided by the number of days in that time period.
<b>Backslope</b>	On a roadway section in a cut, the portion of the roadside that slopes up from the roadside ditch and away from the roadway to the top of the cut, see Figure A-3.
<b>Catchment Area</b>	The total area contributing stormwater runoff to a particular point, site, or structure.
<b>Collector</b>	A road that links local roads with arterials and performs some duties of each. Collectors have managed access with a moderate number of intersections and driveways.
<b>Curve Return</b>	The curve located at the corner of an intersection, connecting the roadway edge of one road to the roadway edge of an intersecting road or driveway.
<b>Detention</b>	The temporary storage of runoff, for later controlled release.
<b>Drainage Pattern</b>	The configuration of a drainage system including manmade and natural features within a catchment area.
<b>Driveway</b>	A vehicular access way between a road and a parking area within a lot or property.
<b>Embankment</b>	Earthen material that is placed and compacted for the purpose of raising the grade of a roadway.
<b>Engineer</b>	An individual who is registered as a Professional Civil Engineer in the State of Alaska.

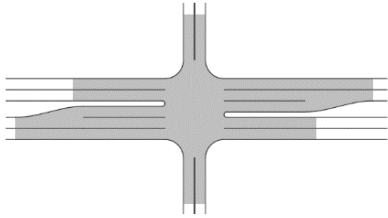
<b>Feasible</b>	Reasonable and capable of being done or carried out.
<b>Foreslope</b>	On a roadway section, the portion of the roadside that slopes down and away from the roadway, see Figure A-3.
<b>Functional Area</b>	<p>The physical area of an intersection and the area extending both upstream and downstream which includes perception reaction distance, maneuver distance, and storage length.</p> 
<b>Intersection</b>	The general area where two or more roads join or cross.
<b>Local Road</b>	A road that provides access to abutting property, rather than to serve through traffic. Local roads are not access controlled and can have frequent intersections and driveways.
<b>Lot Frontage</b>	A property line that abuts the right-of-way that provides access to the lot.
<b>Ordinary High Water Mark</b>	The elevation marking the highest water level which has been maintained for a sufficient time to leave evidence upon the landscape. Generally, it is the point where the natural vegetation changes from predominately aquatic to upland species.
<b>Positive Drainage</b>	Clear, unobstructed flow of water away from structures and roadways without localized ponding.
<b>Public Use Easement</b>	Provides the rights for ingress, egress, roadways, right-of-way, public utilities, and slopes for cuts and fills. The rights are to the public in general, and public utilities governed by permits required under federal, state, and local laws and regulations. May also be known as a public access easement or right-of-way.
<b>Regulated Stream</b>	Any watercourse along which the flood hazard areas have been mapped and approved by the Federal Emergency Management Agency; any stream which harbors fish, as determined by the Alaska Department of Fish and Game; or any stream designated as regulated by MSB.
<b>Retention</b>	The prevention of runoff. Stormwater, which is retained, remains indefinitely, with the exception of the volume lost to evaporation, plant uptake, or infiltration.

<b>Right-of-way</b>	A strip of land reserved, used, or to be used for a street, alley, walkway, airport, railroad, or other public or private purpose.
<b>Road</b>	A general term denoting a public thoroughfare used, or intended to be used, for passage or travel.
<b>Road Prism</b>	The foundation that supports the roadway; see Figure A-3.
<b>Roadway</b>	The portion of a road that includes driving lanes and shoulders, see Figure A-3.
<b>Segment</b>	A portion of road between two significant intersections or an intersection and its terminus.
<b>Shoulder</b>	The portion of a roadway contiguous to any traveled way for lateral support of surface courses, see Figure A-3.
<b>Street</b>	A general term usually denoting an urban or suburban road.
<b>Stub Road</b>	A road segment, typically short in length, which terminates at the boundary of a subdivision or site plan, the purpose of which is to ultimately connect to abutting property when it is developed.
<b>T-intersection</b>	A three leg intersection in the form of a “T”.
<b>Through Street</b>	A road given preferential right of way; roads which intersect a through street are controlled, such as with a stop sign or yield sign.
<b>Water Body</b>	A permanent or temporary area of standing or flowing water. Water depth is such that water, and not air, is the principal medium in which organisms live. Water bodies include, but are not limited to: lakes, ponds, streams, rivers, sloughs, and all salt water bodies.

## Introduction

This manual is intended to accomplish the following goals:

- (1) To establish standards for the design and construction of transportation networks throughout the Matanuska-Susitna Borough.
- (2) To provide information and guidelines for the design, construction, and upgrade of roads, drainage facilities, and utilities within rights-of-way.
- (3) To develop and maintain a safer and more efficient transportation system.
- (4) To minimize operation & maintenance efforts.

## **Section A. Street Design**

### **A01 General**

These provisions establish appropriate standards for the design of roads. The purpose of these provisions is to:

- (1) promote the safety and convenience of motorized and non-motorized traffic;
- (2) promote the safety of neighborhood residents;
- (3) minimize the long term costs for maintenance and repair;
- (4) protect the residential qualities of neighborhoods by limiting traffic volume, speed, noise, and air pollution;
- (5) encourage the efficient use of land; and
- (6) minimize the cost of road construction and thereby restrain the rise in housing costs.

### **A02 Applicability**

These standards apply to the design and construction of all subdivision improvements within the Matanuska-Susitna Borough (MSB), with the exception of those streets within cities that exercise road powers by ordinance.

### **A03 Street Classifications**

Roads within the MSB fall within one of the following functional classifications, in accordance with the Long Range Transportation Plan (LRTP): Interstate, Principal Arterial, Minor Arterial, Major Collector, Minor Collector, and Local Road. Functional classification of a road is based on its function, design, and current potential use. The applicant may request review of the functional classification of existing roads abutting or affecting the design of a subdivision or land development during the preapplication process.

This section provides design guidance for roads falling under local road and minor collector functional classifications.

#### **A03.1 Residential Street**

Residential streets are local roads intended to carry the least amount of traffic at the lowest speed. The Residential street will provide the safest and most desirable environment for a residential neighborhood. Developments should be designed so that all, or the maximum number possible, of the homes will front on this class of street.

#### **A03.2 Residential Subcollector Street**

Residential Subcollector streets are local roads that carry more traffic than Residential streets.

### A03.3 Residential Collector Street

Residential Collector streets are the highest order of residential streets and are a type of minor collector. In large residential developments, this class of street may be necessary to carry traffic from one neighborhood to another or from the neighborhood to other areas in the community. Residential Collector streets should provide the fewest direct accesses as possible.

### A03.4 Mountain Access Road

Mountain Access Roads may be used in areas where the average cross slope exceeds 15 percent or to traverse terrain features in excess of 25 percent. Maintenance of Mountain Access Roads will be at the discretion of DPW. School bus access should be considered as school bus routes require all grades less than 10 percent. Mountain Access Road standards allow for steeper grades and switchbacks, but should otherwise be designed to Residential, Residential Subcollector, or Residential Collector standard as required by this section.

### A03.5 Pioneer Road

Pioneer Roads may only be used where allowed by MSB or other applicable code. This classification establishes minimum requirements for roads providing physical access, but should otherwise be designed to Residential, Residential Subcollector, or Residential Collector standard as required by this section. No MSB maintenance will be provided for Pioneer Roads. Pioneer roads may be constructed offset from the centerline of the ROW to facilitate future expansion of the road.

### A03.6 Alleys

Alleys are permitted provided legal and physical access conforms to MSB or other applicable code. No MSB maintenance will be provided for Alleys.

### A03.7 Other Street Types

The above classifications may be further typed as one of the following streets. These other street types should be designed to Residential, Residential Subcollector, or Residential Collector standard as required by this section.

- (a) Frontage Street – streets parallel and adjacent to a major road corridor which provides access to abutting properties and separation from through traffic. See Section B for additional design standards.
- (b) Backage Street – streets that provide access to lots located between the Backage Street and a major road corridor. See Section B for additional design standards.
- (c) Connector Street – the portion of a street that connects a frontage or backage street to a major road corridor. See Section B for additional design standards.
- (d) Divided Street – streets may be divided for the purpose of accommodating environmental features or avoiding excessive grading. In such a case, the design standards shall be applied to the appropriate street classification and a single lane width with a shoulder on each side.

## A04 Access Criteria

### A04.1 Residential Street

- (a) A Residential street provides access to abutting properties.
- (b) The anticipated average daily traffic (ADT) volume on Residential streets shall not exceed 400. A loop street shall be designed such that the anticipated ADT at each terminus of the loop street does not exceed 400, see Figure A-1.
- (c) Residential streets may intersect or take access from an equal or higher classification street. Both ends of a loop Residential street are encouraged to intersect the same collecting street and be designed to discourage through traffic.
- (d) Residential streets with only one inlet/outlet shall provide access to no more than 20 lots and not exceed 1000 feet in length (measured from the intersection point to the center point of the turnaround).

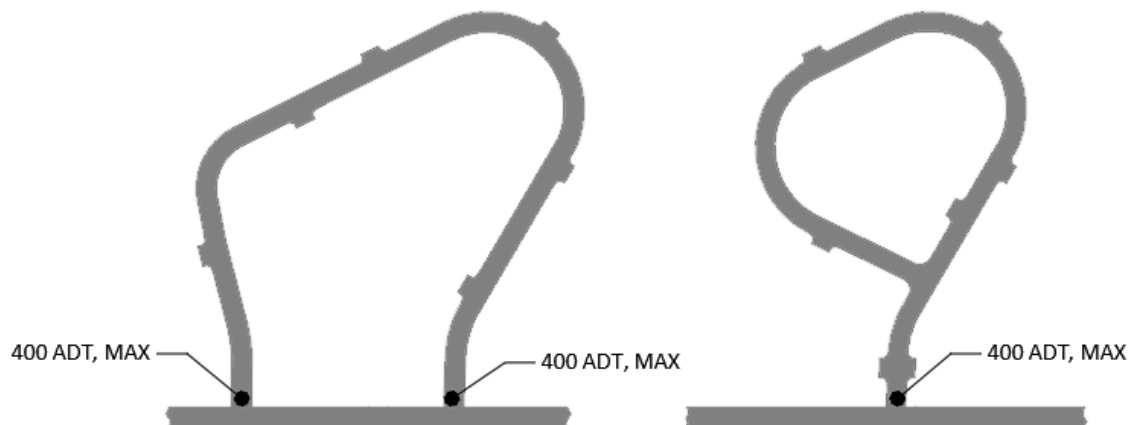

Figure A-1: Loop Residential Streets

### A04.2 Residential Subcollector Street

- (a) A Residential Subcollector street provides access to abutting properties and may also move traffic from Residential streets that intersect it. Residential Subcollector streets are required when the ADT anticipated on the street will exceed the limits for Residential or when a street with only one inlet/outlet provides access to more than 20 lots or exceeds 1000 feet in length.
- (b) The anticipated ADT on Residential Subcollector streets shall not exceed 1000. A loop street shall be designed such that the anticipated ADT at each terminus of the loop street does not exceed 1000, see Figure A-2.
- (c) Residential Subcollector streets shall be designed to exclude all external through traffic that has neither origin nor destination on the Residential Subcollector or its tributary Residential streets. Adjacent parcels may acquire access if proven landlocked by legal or terrain features or if such Residential Subcollector access can be demonstrated to be beneficial to the public.
- (d) Residential Subcollector streets shall take access from a street of equal or higher classification.

- (e) Traffic calming elements should be considered for the design of Residential Subcollectors, such as avoiding long, straight segments and reducing the length of roadway from farthest lot to a collector.
- (f) Residential Subcollector streets shall be provided with two continuous moving lanes within which no parking is permitted.

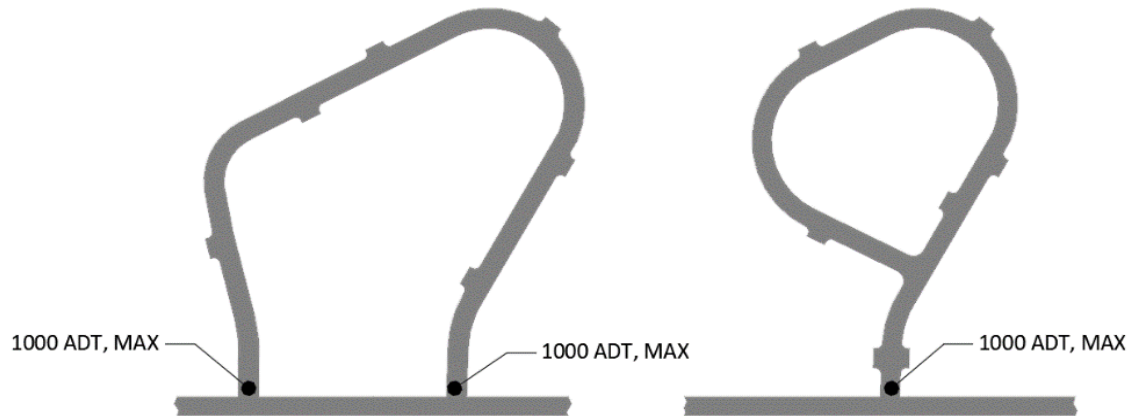

Figure A-2: Loop Residential Subcollector Streets

#### A04.3 Residential Collector Street

- (a) A Residential Collector street carries residential neighborhood traffic, but restricts or limits direct residential access. Residential Collector streets are required when the ADT anticipated on the street will exceed the limits for Residential Subcollectors.
- (b) Residential Collector streets should be designed to have as few residential lots directly fronting them as possible. When efficient subdivision design or physical constraints make this not possible, the average access point spacing shall be a minimum of 250 feet. Average access point spacing is calculated per segment and is equal to the segment length divided by the number of potential access points on both sides of the street. Undeveloped lots with only access to Residential Collector streets are counted as having at least one access point. When the average access point spacing on a segment of an existing Residential Collector street is less than 250 feet, the average access point spacing shall not decrease due to the subdivision.
- (c) Space shall be provided on these lots for turnaround so that vehicles will not have to back out onto Residential Collector streets.
- (d) Proposed access points on Residential Collector streets shall be shown on the preliminary plat.
- (e) Residential Collector streets shall be laid out to encourage connectivity within the transportation network.
- (f) If the anticipated ADT will exceed 3000, the street shall be classified at a higher level than Residential Collector by DPW.
- (g) Every Residential Collector shall be provided with no fewer than two access intersections to streets of equal or higher classification. If it is shown by the applicant that two accesses are not feasible, Residential Collector streets shall be provided with access to one street of equal or higher



classification and be designed to accommodate a future second connection to a street of equal or higher classification, or otherwise be approved by DPW.

- (h) All Residential Collector streets shall be provided with two continuous moving lanes within which no parking shall be permitted.

#### A04.4 Access through Existing Streets

The anticipated ADT on existing Residential streets used to access a proposed subdivision may exceed 400, but shall not exceed 800, if:

- (a) alternate road corridors are not available or feasible;
- (b) horizontal geometry or access density prohibits upgrade to a higher standard road; and
- (c) the traffic impacts are mitigated.

#### A04.5 Traffic Impact Mitigation for Access through Existing Streets

Traffic impact mitigation on existing residential streets can include but is not limited to:

- (a) Traffic control devices (signage, striping) on segments where potential ADT exceeds 440;
- (b) LED street lighting, speed feedback signs, widened shoulders, inside corner widening for offtracking, or all-way stop intersections on segments where potential ADT exceeds 600.

#### A04.6 Commercial Uses on Residential and Residential Subcollector Streets

Exceptions to the ADT limits on Residential and Residential Subcollector streets, as set forth in A04.1 and A04.2, respectively, may be allowed for commercial uses that access the first 600 feet of such streets that intersect a Collector standard road or higher classification, as measured from the intersection point. The affected portion of the street and intersection shall be constructed to a higher standard as needed to accommodate the anticipated commercial traffic.

### A05 Design Criteria

The design criteria for Residential, Residential Subcollector, and Residential Collector streets and Mountain Access and Pioneer roads are set forth in Table A-1. Any unspecified design criteria shall meet or exceed the design criteria for the roadway design speed in the latest edition of *A Policy on Geometric Design of Highways and Streets* (AASHTO).

Table A-1: Design Criteria

	Unit	Residential	Residential Subcollector	Residential Collector	Mountain Access <sup>1</sup>	Pioneer <sup>1</sup>
Average Daily Traffic	VPD	≤400	401 – 1000	1001 – 3000	–	–
<b>Typical Section</b>						
ROW Width <sup>2</sup>	ft	60	60	60	60	60
Lane Width	ft	10	10	11	10	10
Standard Gravel Shoulder Width	ft	2	2	2	0 <sup>3</sup>	0 <sup>3</sup>
Shared Paved Shoulder Width <sup>4</sup>	ft	4	4	6	–	–
Roadway Width	ft	24	24	26	20	20
Foreslope <sup>5</sup>	h:v	3:1	3:1	4:1	2:1	3:1
Backslope <sup>6</sup>	h:v	2:1	2:1	2:1	2:1 <sup>7</sup>	2:1
Crown, gravel	%	3	3	3	3	3
Crown, pavement	%	2	2	2	2	–
<b>Engineering Criteria</b>						
Design Speed	mph	25	30	35	–	–
Posted Speed	mph	20	25	30	–	–
Stopping Sight Distance	ft	155	200	250	–	–
<b>Horizontal Alignment</b>						
Minimum Centerline Radius	ft	225	350	550	– <sup>8</sup>	–
with DPW Approval	ft	190	275	400	–	–
Minimum Tangent Between Curves	ft	100	100	100	100	100
Maximum superelevation	%	N/A	N/A	4	N/A	N/A

<sup>1</sup> Where a value is not given, Mountain Access and Pioneer Roads shall meet the criteria of the anticipated street classification.

<sup>2</sup> Minimum ROW required for new dedications; width of existing ROW may vary.

<sup>3</sup> Where grades exceed 7 percent, the shoulder width shall be 2 feet for a total roadway width of 24 feet.

<sup>4</sup> An optional paved shoulder may be provided on one or both sides of paved streets for non-motorized shared use.

<sup>5</sup> Slope for the first 7.5 feet from the shoulder; may be steepened to 2:1 thereafter. Install guardrail when required by the latest edition of the *Roadside Design Guide* (AASHTO).

<sup>6</sup> 2:1 Back slopes may be steepened to 1.5:1 if cuts exceed 5 feet and appropriate slope stabilization, as determined by the design engineer, is used. Retaining walls may be used to replace or augment backslopes.

<sup>7</sup> Or backslope recommended by the design engineer based on actual conditions.

<sup>8</sup> Switch backs are allowed provided cul-de-sac criteria is met or turning radius is 40 feet with a 2% grade.

	Unit	Residential	Residential Subcollector	Residential Collector	Mountain Access <sup>1</sup>	Pioneer <sup>1</sup>
<b>Vertical Alignment</b>						
Maximum Centerline Grade	%	10	10	10	15 <sup>9</sup>	10
Minimum Rate of Vertical Curvature <sup>10</sup> ; Crest		12	19	29	–	–
Minimum Rate of Vertical Curvature <sup>10</sup> ; Sag		26	37	49	–	–
Minimum Flow Line Grades	%	0.5	0.5	0.5	1.0	0.5
<b>Intersections</b>						
Minimum ROW Corner Radius	ft	30	30	30	30	30
Minimum Curve Return Radius <sup>11</sup>	ft	20	25	30	–	–
Maximum Grade on through street within 50 feet of intersection	%	7	7	4	9	7

<sup>9</sup> Up to 15% grade with no more than 200 linear feet of over 10% grade with a minimum of 100 linear feet of less than 10% grade for runout between steeper sections. Maximum grade in a horizontal curve is 10%.

<sup>10</sup> Rate of vertical curvature (K) is the length of curve (L) in feet per percent algebraic difference in intersecting grades (A);  $K = L / A$

<sup>11</sup> 40-foot minimum curve return radius at intersections with higher order streets.

## A06 Typical Section

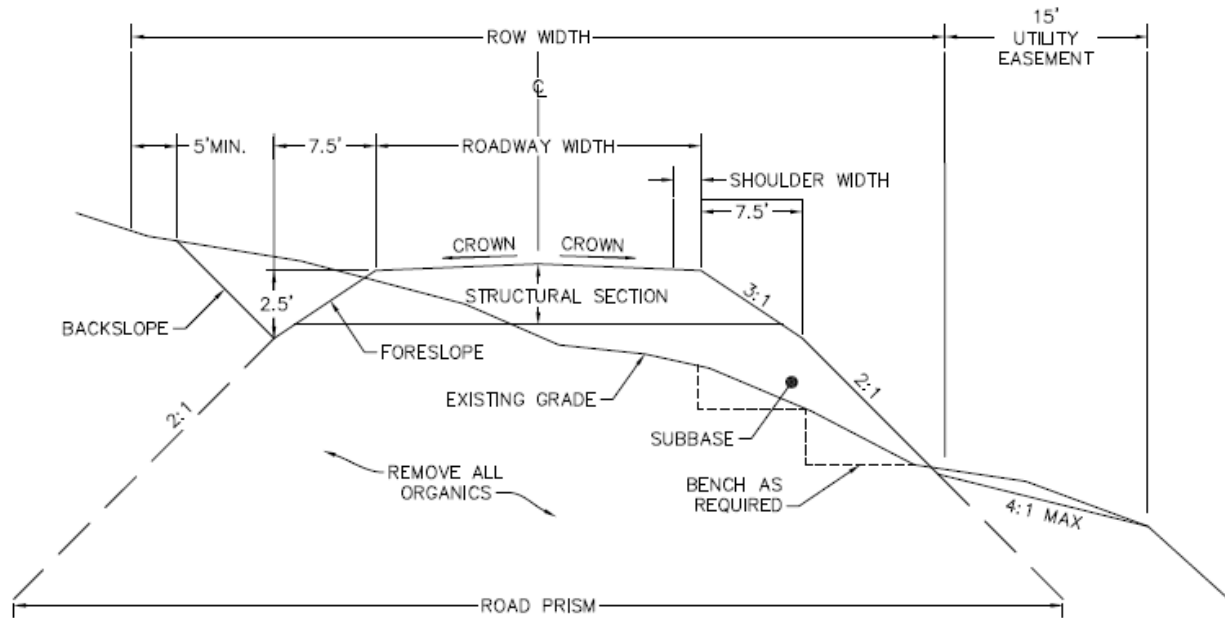

Figure A-3: Typical Section

## A07 Turnarounds

Streets that exceed 200 feet in length (measured from the intersection point to the end of required construction) shall terminate with a constructed turnaround.

### A07.1 Cul-de-sac Turnarounds

- (a) A cul-de-sac turnaround with a drivable surface diameter (shoulder to shoulder) of 85 feet centered in a ROW diameter of 120 feet shall be provided at the terminus of Residential and Residential Subcollector streets.
- (b) Cul-de-sac turnarounds shall meet the configuration and dimensions shown in Figure A-4.
- (c) The grade throughout the surface of a cul-de-sac shall not exceed 4 percent.

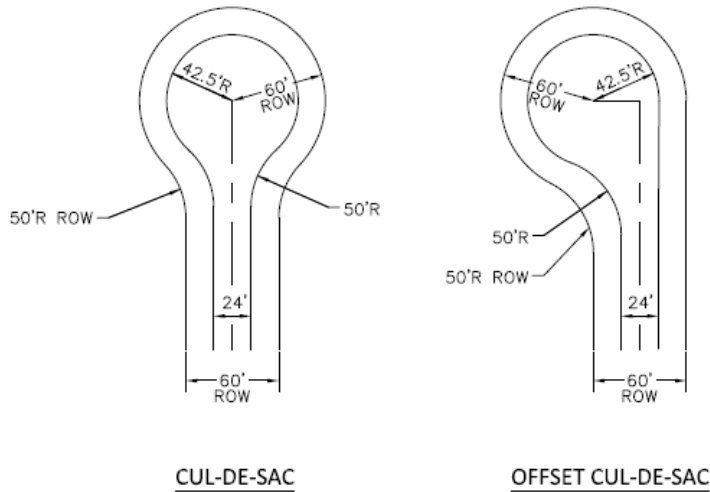

Figure A-4: Cul-de-sac Options

### A07.2 Alternate Turnarounds

- (a) DPW may permit a street to terminate with an alternative turnaround that meets fire code when such a design is required by extreme environmental or topographical conditions, unusual or irregularly shaped tract boundaries, or when the location of the turnaround is intended to become an intersection.
- (b) Alternate turnarounds shall meet the configuration and dimensions shown in Figure A-5.
- (c) The grade throughout the turnaround surface shall not exceed 4 percent.

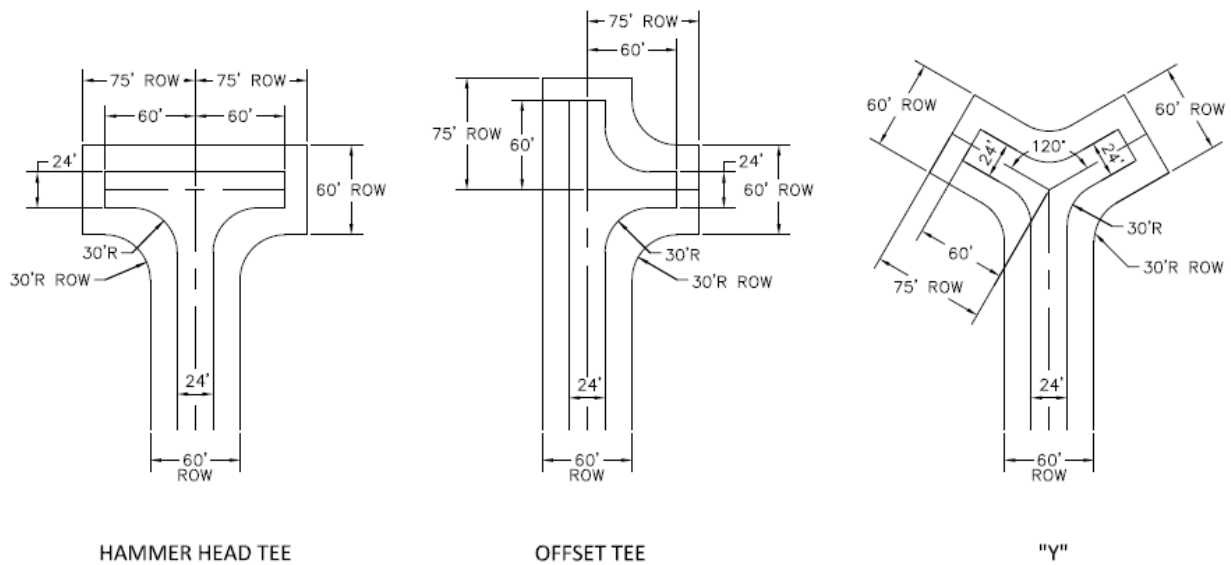

Figure A-5: Alternate Turnarounds

## A08 Stub Streets

### A08.1 Stub Street Construction

No construction is required if physical access is provided to all lots by adjoining streets as required by MSB or other applicable code.

### A08.2 Temporary Turnarounds

All stub streets requiring construction will meet the requirements of A07. A temporary easement will be provided for the turnaround which will automatically terminate upon extension of the street and physical removal of the turnaround.

## A09 Intersections

### A09.1 Intersection Sight Distance

- (a) Whenever a proposed street intersects an existing or proposed street of higher order, the street of lower order shall be made a stop controlled street, unless alternate intersection control is used as allowed by this subsection.
- (b) Stop controlled streets shall be designed to provide intersection sight distance as specified in this subsection, Table A-2, and Figure A-6.
- (c) The entire area of the intersection sight triangles shown in Figure A-6 shall be designed to provide a clear view from point A at 3.5 feet above the roadway to all points 3.5 feet above the roadway along the lane centerlines from point B to point C and point D to point E.
- (d) Sight distances less than the recommended shall only be used when there are topographical or other physical constraints outside of the applicant's control.
- (e) The minimum sight distances listed in Table A-2 are for a passenger car to turn onto a two-lane undivided street and minor road approach grades of 3 percent or less. For other conditions, the minimum sight distance should be calculated by the applicant's engineer according to *A Policy on Geometric Design of Highways and Streets* (AASHTO).
- (f) Sight distances less than the minimum, where no other options exist, will require alternate intersection control or warning signs as determined by the applicant's engineer and approved by DPW.
- (g) Intersection sight triangles shall be located in their entirety within ROW or a sight distance maintenance easement.
- (h) Yield controlled intersections shall conform to sight distance requirements according to *A Policy on Geometric Design of Highways and Streets* (AASHTO).
- (i) Intersections with state or other municipal ROW are subject to their respective requirements and review.

Table A-2: Recommended and Minimum Intersection Sight Distance

Design Speed or Posted Speed Limit (whichever is greater)	S <sub>d</sub> Recommended	S <sub>d</sub> Minimum
MPH	ft	ft
25	370	280
30	450	335
35	580	390
40	750	445
45	950	500
50	1180	555
55	1450	610
60	1750	665
65	2100	720

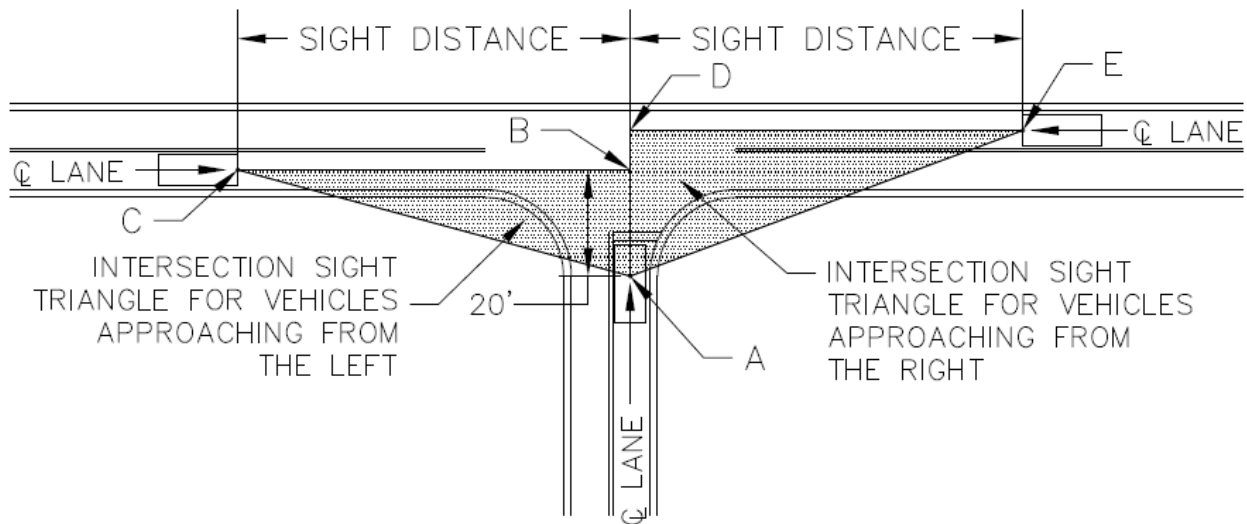

Figure A-6: Intersection Sight Distance

### A09.2 Intersection Spacing

- (a) Minimum centerline to centerline distance between intersections on the same side or opposing sides of the through street shall be:
  - (1) 155 feet on Residential streets;
  - (2) 200 feet on Residential Subcollector streets;
  - (3) 300 feet on Residential Collectors and Minor Collectors; or
  - (4) 650 feet on higher order streets where other access standards do not exist.
- (b) If the above spacing along the through street cannot be met, intersections shall be aligned directly across from each other. Intersections on opposing sides of the through street may be offset up to 30 feet, with a preference for a left-right offset, as shown in Figure A-7.

- (c) Where pre-existing conditions do not allow for the above spacing and no other legal access exists, alternate spacing or offset most closely meeting (a) or (b) above may be allowed.
- (d) Additional intersections should be avoided within the functional area of major intersections with turning bays and approach tapers. Exceptions require DPW approval based upon constraints and no other feasible alternatives.

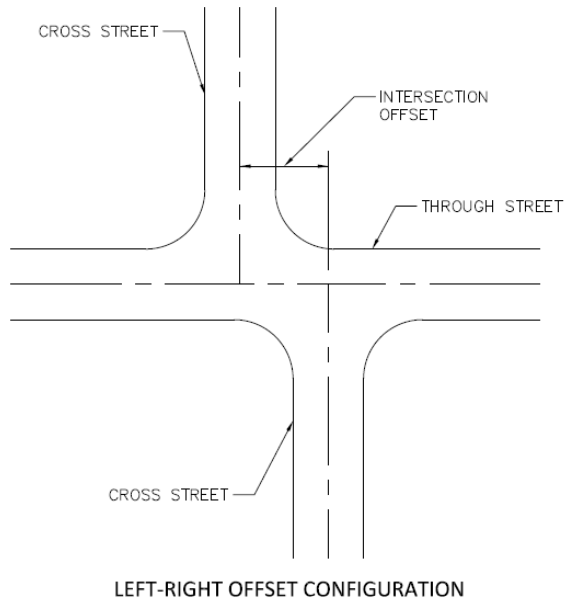

Figure A-7: Intersection Offset

### A09.3 Minimum Intersection Angle

Streets should intersect with a straight segment at an angle as close to 90° as possible, but no less than 70°, for a minimum of 75 feet from the intersection point, as shown in Figure A-8.

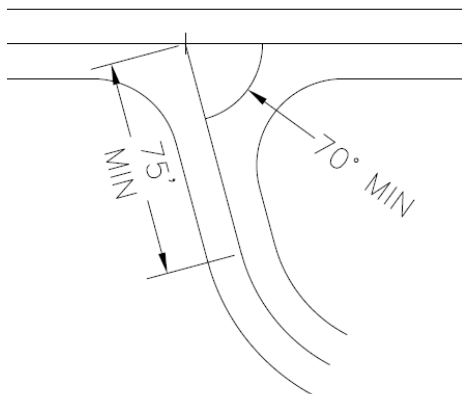

Figure A-8: Intersection Angle



#### A09.4 Landing

Controlled streets shall be provided with a 30-foot landing, conforming to Figure A-9, at its approach to a through street. The landing shall be sloped to match the crown of the through street. Vertical curves shall not be located in the landing to the extent feasible.

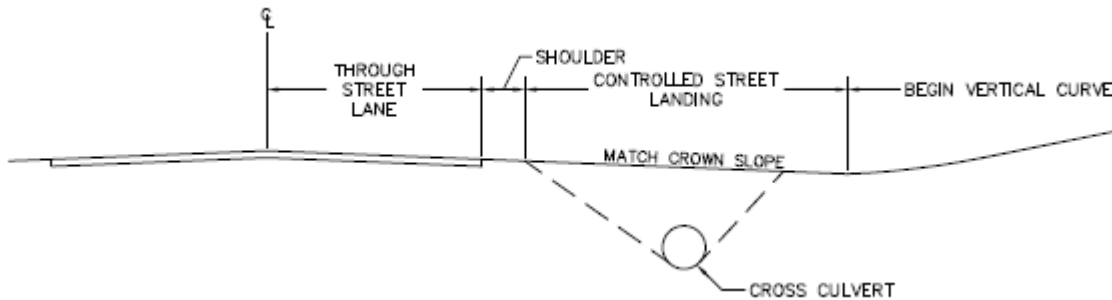

Figure A-9: Controlled Street Landing Profile

#### A09.5 Paved Apron

A proposed street which intersects an existing paved street shall be provided with a paved apron from the edge of the existing pavement to the end of the curve return plus 10 feet.

#### A10 Driveways

Driveways are not usually required to be constructed within the ROW at time of road construction. However, if an applicant chooses to construct driveways, driveway permits are required. The applicant may permit all driveways with one application. A driveway permit application can be obtained from the MSB Permit Center. Driveways onto state or other municipal ROW are subject to their respective requirements and review.

#### A11 Trailhead

Trailhead parking lot layout shall conform to applicable local, state, and federal requirements.

#### A12 Bicycle and Pedestrian Paths

Bicycle and pedestrian paths constructed within public ROW shall conform to the current edition of *Guide for the Development of Bicycle Facilities* (AASHTO), and any other applicable local, state, and federal requirements.

#### A13 Signage

Signs shall be provided and installed by the applicant in conformance with the latest edition of the *Alaska Traffic Manual* (ADOT&PF) and the *Alaska Sign Design Specifications* (ADOT&PF) prior to plat recordation.

- (a) Each street within a subdivision shall be identified and signed at its point of egress and ingress. Cul-de-sac streets will be signed and identified at their point of ingress
- (b) Intersection control signs shall be provided at designated intersections within the confines of the subdivision and at the intersection with the access road, if applicable.
- (c) Intersection control signs shall be located such that they are visible to approaching traffic and near corresponding stop or yield bars.
- (d) Speed limit signs shall be provided at entrances to the subdivision, where the speed limit changes, and at a minimum of one-mile intervals throughout the subdivision.
- (e) If a constructed stub street provides access to two or fewer lots and has no turnarounds a sign indicating a dead-end street shall be posted.
- (f) If a dedicated stub street is not constructed, no signs are required.
- (g) Install signs according to the criteria in Figure A-10, Figure A-11, and Figure A-12.
- (h) Signs within state or other municipal ROW are subject to their respective requirements and review.

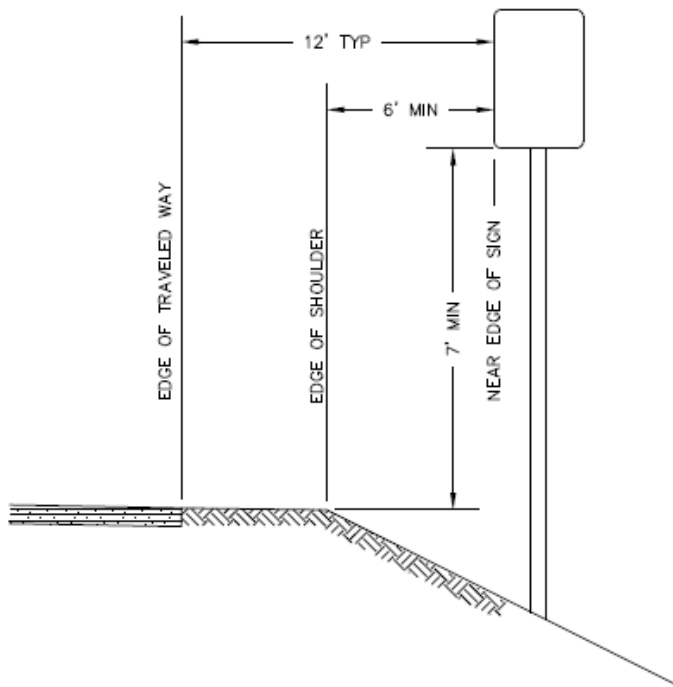

Figure A-10: Sign Placement

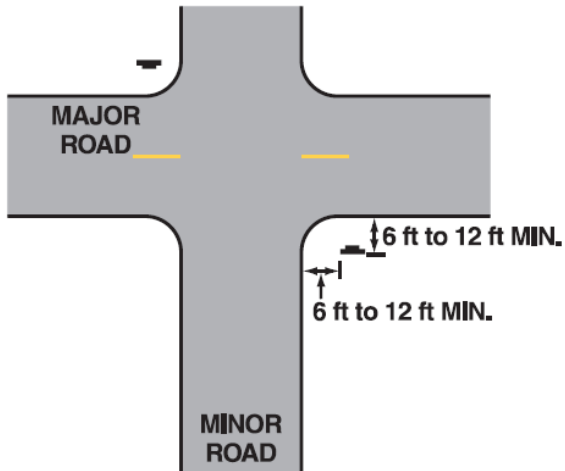
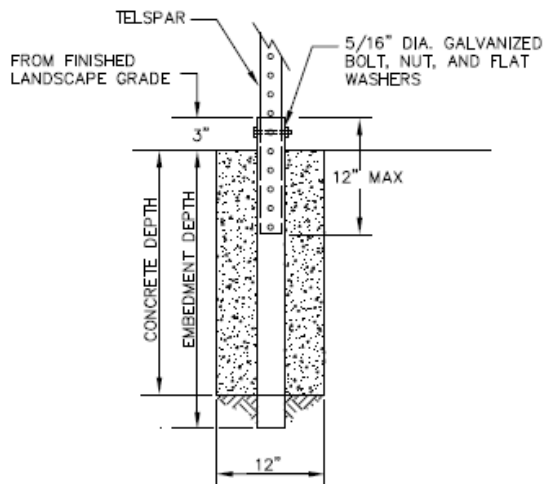

Figure A-11: Stop Sign Location



PERFORATED STEEL TUBES (P.S.T.) (12ga. - .105" Wall Thickness)			
SIGN SURFACE AREA SQ. FT.	POST SIZE	EMBEDMENT DEPTH	CONCRETE DEPTH
7' OR LESS	2" X 2"	27"	24"
GREATER THAN 7'	2 ½" X 2 ½"	33"	30"

Figure A-12: Concrete Foundation for Sign Post

## A14 Railroad Crossings

All access requiring a crossing of the Alaska Railroad shall be subject to the *Alaska Policy on Railroad/Highway Crossings* (Alaska Railroad).

### **A15** Average Daily Traffic

- (a) The following formula shall be used to determine the required classification of streets:  
ADT = Number of lots x 10 for single-family residential use.
- (b) See Section G for other land uses.
- (c) For subdivisions of five or more lots, submit potential ADT calculations for the following locations with the preliminary plat:
  - (1) at each intersection within the subdivision,
  - (2) at each intersection en route to an existing Residential Collector street or higher classification, and
  - (3) at an existing Residential Collector street or higher classification.

### **A16** Design Deviations

Design deviations will be considered to address extenuating circumstances including but not limited to: existing substandard ROW, environmental conditions, or existing utilities or other structures. Design deviation requests shall be in writing and contain supporting information, justification, and suggested solutions. Design deviations may be allowed by DPW only for matters that do not fall under the jurisdiction of a Board or Commission. In no circumstances will a roadway width less than 20 feet or foreslopes steeper than 2:1 be allowed. Residential Collector streets shall be no less than 24 feet wide.

## Section B. Major Road Corridors

### B01 General

Major road corridors include major collectors, arterials, and interstates. This section provides references to and guidelines for the design and construction of major road corridors within the MSB.

### B02 Right-of-way and Surface Widths

Classification	Minimum ROW Width (ft)	Standard Lane Width (ft)	Number of Lanes	Shoulder Width (ft)
Major Collector	80	12	2 – 3	4
Arterial	100	12	3 – 4	4 – 8
Interstate	200	12	4 – 6	12

### B03 Frontage, Backage, and Connector Street Standards

Subdivisions adjacent to planned or existing major road corridors shall plan for future frontage or backage streets when any of the following conditions apply, unless it is shown by the applicant to be not necessary or feasible for future development and public safety with non-objection from the road authority.

- (a) Subdivisions accessing roads that are classified by ADOT&PF as Interstates.
- (b) Subdivisions accessing roads that are or are projected to grow above 20,000 vehicles per day (VPD).
- (c) Subdivisions accessing roads that are or are projected to have four or more lanes or median control per the LRTP or OSHP.
- (d) Subdivisions that require a second access route.
- (e) To gain access to an existing or planned signal.
- (f) Where access to a minor arterial or collector as a connector road is feasible.
- (g) When there are existing or platted frontage or backage routes adjacent to the property.

#### B03.1 Separation Distances

Minimum ROW to ROW separation distance between major corridors and frontage or backage streets shall be:

- (a) 0 feet for locations with no connector street to the major road corridor;
- (b) 100 feet for locations with a connector street to the major road corridor that lie between section lines and planned or existing intersections with other major road corridors;
- (c) 300 feet for locations where the connector street to the major road corridor is on a section line or planned or existing major road corridor.

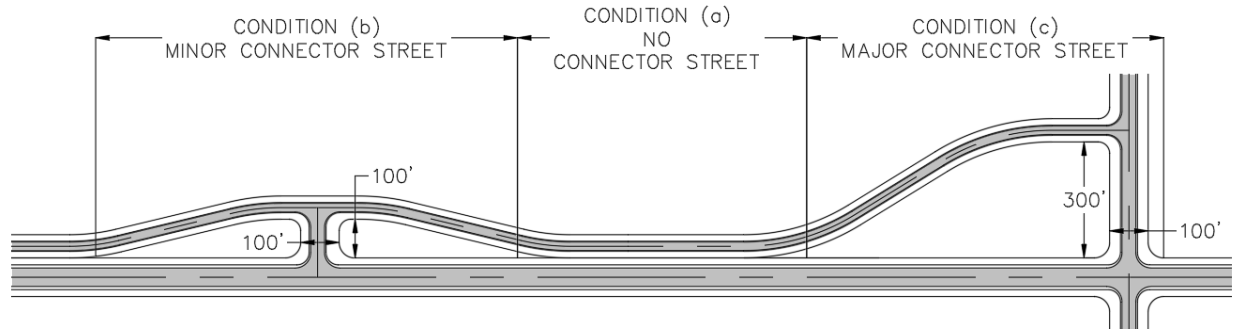

Figure B-1: Frontage Street Configurations

### B03.2 Design Standards

- (a) Frontage streets
  - (1) Minimum centerline radii may be reduced near intersections with through connector streets.
- (b) Connector streets
  - (1) 100-foot ROW width desirable.
  - (2) Minimum 40-foot radius curve returns at the major road corridor.
  - (3) Minimum 4-foot wide shoulders for 100 feet from the edge of roadway of the major road corridor.
  - (4) Minimal direct access.

### B03.3 Dedication and Setbacks

Dedicate ROW or additional building setbacks to allow for the frontage, backage, and connector street standards in this manual. The applicant shall prove that frontage, backage, and connector street dedications or building setbacks are in a practical location where road construction is feasible in accordance with this manual. The applicant shall be required to submit plan, profile, and cross-sections if existing grades along the proposed route exceed 10 percent, existing cross slopes exceed 15 percent, or if existing utilities or other physical features appear to create impediments to a road design meeting standards of this manual.

### B04 Access Standards

- (a) The average access point spacing on major road corridors, where other access standards do not exist, shall not exceed the minimums listed in Table B-1, based on the posted speed limit. Average access point spacing is calculated per segment and is equal to the segment length divided by the number of access points on both sides of the street. Undeveloped lots with only access to the major road corridor are counted as having at least one access point.
- (b) When the average access point spacing on a segment of an existing major road corridor is less than the minimum listed in Table B-1, the average access point spacing shall not decrease due to the subdivision.

Table B-1: Average Access Point Spacing

Posted Speed Limit (mph)	Minimum Average Access Point Spacing (feet)
30	250
35	300
40	360
45	425
50	495
55	570

### B05 Future Corridors

Subdivisions shall be designed in a manner that does not conflict with the Long Range Transportation Plan or the Official Streets and Highways Plan. Subdivisions containing future road corridors identified in the LRTP or OSHP are encouraged to include the future road corridor as part of the road layout of the subdivision.

Building setbacks prohibiting the location of any permanent structure within the future corridor may be voluntarily designated on the final plat. The area within the future road corridor shall be excluded from usable septic area calculations. The area within the future road corridor and building setbacks shall be excluded from usable building calculations.

### B06 References

The following publications shall be used for design and construction standards of these classes of streets that are not otherwise established herein:

- (a) *A Policy on Geometric Design of Highways and Streets*, AASHTO (current edition).
- (b) *Standard Specifications for Highway Construction*, ADOT&PF (current edition);
- (c) *Standard Modifications to the ADOT&PF Standard Specifications for Highway Construction*, MSB (latest revision)
- (d) *Alaska Highway Preconstruction Manual*, ADOT&PF (latest revision)

## Section C. Construction Requirements

### C01 General

This section establishes minimum construction requirements. Prior to any ground disturbing activities, call the Alaska Dig Line for utility locates in accordance with AS 42.30.400.

### C02 Road Construction

#### C02.1 Clearing

Cut and dispose of all trees, down timber, stumps, brush, bushes, and debris. Cut trees and brush to a height of not more than 6 inches above the surrounding ground. Clear the ROW, slope easements, and sight distance triangles. Where ROW exceeds 60 feet, clear a minimum of 60 feet. Clear utility easements, if used, for utilities constructed with the development.

#### C02.2 Grubbing

Remove and dispose of all stumps, roots, moss, grass, turf, debris, or other deleterious material within the fill and cut catch limits of the road plus 5 feet on each side, within the ROW, and cleared utility easements for underground utilities.

#### C02.3 Disposal

Dispose of clearing and grubbing debris in an area designated by the applicant outside of all ROW, platted utility easements, and platted private road corridors. Organic debris 3 inches in diameter by 8 inches long, or smaller, may be left in place, outside of the road prism.

#### C02.4 Slit Trenches

Slit trenches are not allowed in the ROW. Utility easements may be used as a borrow source above a 2:1 extension of the road prism, as shown in Figure A-3. Topsoil or other organic non-deleterious material may be disposed within the utility easement. Compact the disposal area with heavy equipment and grade the surface with positive drainage no steeper than 4:1 and no lower than the ditch line. Submit an as-built drawing showing the horizontal locations of borrow extraction along the road corridor with the Final Report.

#### C02.5 Embankment Construction

- (a) Construct the road with the required structural section, see Figure C-1, and dimensions, see Table A-1 and Figure A-3, as determined by its classification.
- (b) Prepare the subgrade. Remove all organics from the area below the road prism and dispose in locations where embankment is not proposed. Bench existing slopes that are steeper than 4:1, measured at a right angle to the roadway, where roadway embankment is to be placed.
- (c) Place material meeting, or verify in-situ material meets, the requirements for Subbase specified in subsection C07 to a minimum depth of 20 inches with the upper 6 inches having no material with



a diameter larger than 6 inches. Place embankment in horizontal layers, as directed by the engineer, for the full width of the embankment and compact as specified before the next lift is placed.

- (d) Place 4 inches of Surface Course meeting the requirements specified in subsection C07. Finish with a 3 percent crown, and compact as specified.
- (e) For Residential and Residential Subcollector standard roads, compact all embankment to not less than 90 percent of the maximum dry density and the top 24 inches to not less than 95 percent of the maximum dry density. For Residential Collector standard roads, compact all embankment to not less than 95 percent of the maximum dry density. Compaction tests on the subbase layer shall be taken at representative locations along the roadways as follows:
  - (1) a minimum of three;
  - (2) at least one per segment;
  - (3) one additional test per 1000 linear feet, or portion thereof, when the combined length of roadway exceeds 1000 linear feet;
  - (4) at least one out of every three within three feet of the shoulder, and the remainder in the center of a driving lane.
- (f) For paved roadways, substitute Surface Course with a minimum of 2 inches of Base Course and 2 inches of HMA Type II, Class B, for Residential and Residential Subcollector streets, and a minimum of 3 inches of Base Course and 3 inches of HMA Type II, Class B, for Residential Collector Streets, in accordance with Appendix A. The width of the pavement shall be equal to two lane widths plus the shared paved shoulder width, if used, and finished with a 2 percent crown. Pavement edges shall be backed with additional Base Course graded and compacted flush with the pavement surface and tapered to the edge of the roadway. The pavement shall be washed or swept immediately following shouldering work.
- (g) Remove all loose material exceeding 6 inches in diameter from the ditches and foreslopes. Where slopes are 3:1 or steeper and longer than 10 feet measured along the slope face, trackwalk perpendicular to the slope, or the equivalent, to form 1-inch wide grooves parallel to the road no more than 12 inches apart.
- (h) Permanently stabilize backslopes 3:1 or steeper. Stabilization can be part of a subdivision agreement. Stabilization may be allowed to establish during the warranty period.

### C02.6 Unsuitable Subgrades

When structurally unsuitable material such as peat, saturated material, or permafrost are present within the ROW, provide an appropriate structural design for approval by DPW, according to Section F, prior to construction. Place embankment to a depth that will produce a stable road surface with a final grade 18 inches above the surrounding ground.

### C03 Roads Outside of a Road Service Area

Roads outside of a Road Service Area are not subject to the requirement for Surface Course.

## **C04** Pioneer Road Construction Requirements

Pioneer roads, whether proposed or existing, shall meet the requirements of Figure C-1, Table A-1

Table A-1, and Figure A-3. Place material meeting, or verify in-situ material meets, the requirements for Subbase specified in subsection C07 to a minimum depth of 12 inches. Additional road embankment may be required to provide a stable road surface. Surface Course is not required. Pioneer roads may be constructed offset from the centerline of the ROW to facilitate future expansion of the road. Cross drainage culverts, minimum 18 inch diameter, will be installed where determined necessary and 24 inch ditches will be provided for drainage.

## **C05 Winter Construction**

Winter construction may be allowed. DPW will not accept any roads until all ground has thawed and any settlement areas corrected.

## **C06 Alternate Methods and Materials**

Use of alternate materials and road construction methods that will more appropriately fit the conditions of the specific road locations, following general engineering practices, may be proposed by the applicant or their engineer in writing. Final acceptance of such plans must be approved by DPW.

## **C07 Materials**

### **C07.1 Subbase**

- (a) Is aggregate containing no muck, frozen material, roots, sod, or other deleterious matter;
- (b) has a plasticity index not greater than 6 as tested by Alaska Test Method (ATM) 204 and ATM 205; and
- (c) meets the requirements of Table C-2, as determined by ATM 304.

### **C07.2 Base Course**

- (a) Crushed stone or crushed gravel, consisting of sound, rough, durable pebbles or rock fragments of uniform quality;
- (b) free from clay balls, vegetable matter, or other deleterious matters;
- (c) meets the requirements of Table C-1; and
- (d) meets the requirements of Table C-2, as determined by ATM 304.

### **C07.3 Surface Course**

- (a) Is a screened or crushed gravel, consisting of sound, rough, durable pebbles or rock fragments of uniform quality;
- (b) free from clay balls, vegetable matter, or other deleterious matters; and
- (c) meets the requirements of Table C-2, as determined by ATM 304.

Table C-1: Aggregate Quality Properties for Base Course

Property	Test Method	Base Course
L.A. Wear, %	AASHTO T 96	50, max
Degradation Value	ATM 313	45, min
Fracture, %	ATM 305	70, min
Plastic Index	ATM 205	6, max
Sodium Sulfate Loss, %	AASHTO T 104	9, max (5 cycles)

Table C-2: Aggregate Gradations

Sieve Designation	Subbase	Base Course	Surface Course
1 1/2 inch			100
1 inch		100	
3/4 inch		70 to 100	70 to 100
3/8 inch		50 to 80	50 to 85
No. 4	20 to 60	35 to 65	35 to 75
No. 8		20 to 50	20 to 60
No. 50		6 to 30	15 to 30
No. 200	0 to 10	0 to 6	7 to 13

(Percent Passing By Weight)

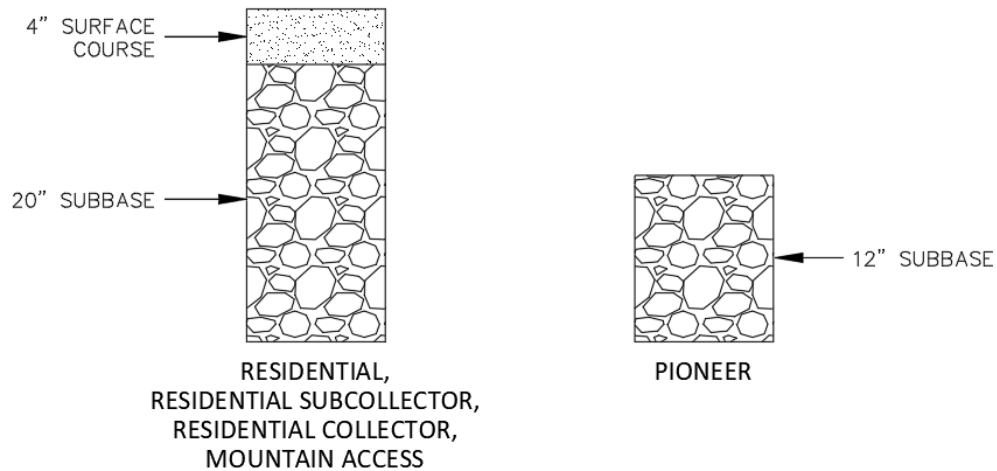

Figure C-1: Structural Sections for Gravel Roads

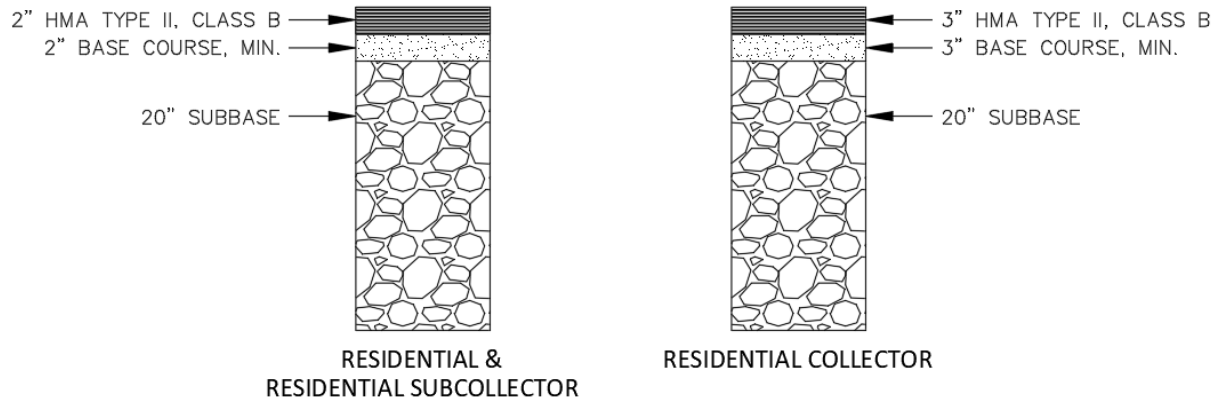

Figure C-2: Structural Sections for Paved Roads

## Section D. Drainage

### D01 General

The purpose of this section is to ensure that stormwater management is provided with land development activities. Responsible stormwater management is the treatment, retention, detention, infiltration, and conveyance of stormwater and other surface waters without adversely impacting adjoining, nearby, or downstream properties and receiving waters.

### D02 Requirements

A preliminary drainage plan is required when road construction or disturbing land to create useable area for a subdivision is proposed. A drainage report is required for projects that include road construction, disturb 10,000 square feet of land or more, fill in wetlands, disturb land within 100 feet of the ordinary high water mark (OHWM) of a water body, disturb land within a mapped flood hazard area, or change the location, direction, quantity, or type of runoff leaving a site. See subsection D06 for specific requirements regarding fish passage culverts. It is the applicant's responsibility to comply with all other applicable federal, state, and local codes and regulations.

#### D02.1 Preliminary Drainage Plan

Submit a preliminary drainage plan, prepared by an engineer or other qualified professional registered in the State of Alaska, with the preliminary plat or ROW construction permit application. The preliminary drainage plan shall show the project site at a legible scale plottable on 11" by 17" paper or larger and depict the following:

- (a) Existing and proposed property lines, plottable easements disclosed in the title report, the OHWM of water bodies with 100-foot upland offset, and existing mapped flood hazard areas.
- (b) Existing topography with horizontal and vertical accuracy meeting US National Map Accuracy standards, with 5-foot contour intervals if the ground slope is less than 10 percent and 10-foot contour intervals if the ground slope is greater than 10 percent.
- (c) Existing features that convey or retain drainage, including but not limited to: water bodies, wetlands, natural valleys, swales, ditches, check dams, culverts, and pipe systems.
- (d) Proposed drainage pattern and features, both constructed and natural, on site. Identify conveyance types, flow directions, and any drainage changes that may affect adjacent property.
- (e) Proposed stream crossings and anticipated culvert sizes. Identify fish-bearing streams.

#### D02.2 Drainage Report

- (a) Submit a drainage report, prepared by an engineer or other qualified professional registered in the State of Alaska, as part of the construction plan submittal in subsection F01.2. The drainage report shall include the following:
- (b) The drainage plan as specified in D02.1 (may be shown on two plans for clarity), updated to include:
  - (1) Pre-development and post-development catchment area boundaries; and

- (2) Locations of peak flow, peak velocity, and where runoff leaves the project site.
- (c) Description of methods, assumptions, and data sources used or made, including but not limited to:
  - (1) Rainfall data used (from NOAA's Precipitation Frequency Data Server or the Palmer Airport IDF curves in Figure D-1, whichever is more appropriate for the local conditions).
  - (2) Assumed post-development land cover conditions.
  - (3) Method used to determine runoff quantities, time of concentration, peak flows, etc.
- (d) Catchment area maps used or created to evaluate down-gradient conditions.
- (e) Identify design elements, with supporting runoff calculations, necessary to show compliance with the drainage design criteria set forth in D03.
- (f) Fish passage culvert plans, if applicable.

### **D03** Drainage Design Criteria

- (a) Design a drainage system for the project site to meet the criteria listed in Table D-1.
- (b) Retain natural drainage patterns to the extent possible.
- (c) Changes to drainage patterns must not adversely affect adjacent property or ROW.
- (d) Base the size and capacity of the drainage system on runoff volumes and flow rates assuming full development of the subdivision and a 10 percent increase to runoff from the catchment area.
- (e) Utility easements may be crossed by drainage features, but cannot be used to retain or detain water. Drainage easements are required where the ROW is not sufficient to accommodate drainage needs. See subsection E01.2.
- (f) Drainage to state or other municipal ROW are subject to their respective requirements and review.

Table D-1: Drainage Sizing and Analysis Criteria

Design Requirement	Purpose	Criteria
Conveyance Design	Size conveyances to pass design peak flows.	Drainage ditches: 10-year, 24-hour Non-regulated streams: 10-year, 24-hour Regulated streams: 100-year, 24-hour
Wetland Retention	Retain function of original wetlands	In areas where wetlands are disturbed, drainage must be designed to preserve the pre-development function of the remaining wetlands. For jurisdictional wetland areas, comply with United States Army Corps of Engineers wetlands development retention requirements.
Water Quality Protection	Treat first flush pollutant loading  Ensure channel stability for all project conveyances	Treat the initial 0.25 inch of post-developed runoff for each storm event.  Control flows in conveyance channels so that transport of particles sized D50 and greater will not occur for the post-development 10-year, 24-hour storm.
Extended Detention	Protect streams and channels from damage from smaller, more frequent storm flows	Provide 12 to 24 hours of detention for the post-development project runoff in excess of pre-development runoff volume for the 1-year, 24-hour storm.
Flood Hazard Protection	Control project peak flow to minimize downstream impacts	Maintain the post-development project runoff peak flow from the 10-year, 24-hour storm to less than 1.10 times pre-development runoff peak flow at all project discharge points. If post-development discharge is greater than pre-development discharge, evaluate down-gradient conditions for and mitigate adverse impacts for a distance of 1 mile downstream from the project as measured along the flow path or to the receiving water body, whichever is less,
Project Flood Bypass	Prevent an increased risk of flood damage from large storm events.	Design or identify an unobstructed, overland flow path for runoff to overtop or bypass project conveyance routes for the post-development 100-year, 24-hour storm.



## D04 Drainage Ditches

Normal ditch depth shall be 30 inches and according to the typical section shown in subsection A06. The ditch depth may be reduced at local high points of the ditch, provided the flow line offset is maintained and with DPW concurrence. Alternate ditch design along Residential and Residential Subcollector streets may be considered, if evidence is provided that the following conditions exist:

- (a) Ditches are a minimum of 18" deep;
- (b) The design peak flow required by Table D-1 is demonstrated to be conveyed within ditches with a minimum freeboard of 12 inches;
- (c) Adequate drainage routes are provided and constructed within the ROW or designated drainage easements;
- (d) Flow lines are established at least 8 feet from the edge of roadway.
- (e) Ditches are deepened to provide cross drainage through 24" corrugated metal culverts (18" with DPW approval).
- (f) Cross sectional area of ditch is at least 15 square feet.

## D05 Culverts

### D05.1 General Culvert Design Criteria

The following criteria apply to all cross road culverts for runoff or seasonal drainage:

- (a) The minimum culvert slope is 0.5 percent.
- (b) Culverts longer than 100 feet require appropriate maintenance access and DPW approval
- (c) Cross road culverts shall have a minimum diameter of 18 inches.
- (d) Culverts shall be sized to convey the design peak flow required by Table D 1, based on the larger of the two computed sizes using inlet control and outlet control.
- (e) Culverts shall be corrugated metal pipe (CMP).
- (f) Install culverts in accordance with the manufacturer's recommendations for the anticipated traffic loads.

### D05.2 Stream Crossing Culvert Criteria

The following criteria apply to all stream crossing culverts:

- (a) Prior to preliminary plat submittal, contact the Alaska Department of Fish and Game (ADFG), Division of Habitat to determine if a stream reach harbors fish. If so, stream crossing culverts shall be designed, constructed, and maintained according to D06.
- (b) Stream crossing culverts shall be placed as close to the pre-existing channel alignment as possible. Avoid placing culverts at pools and stream bends.
- (c) Road alignment shall be as close to perpendicular to the stream channel as possible.
- (d) Culvert slope shall be within 25 percent of the natural stream slope. For example, if the natural stream slope is 1.0 percent, the minimum design slope of the culvert would be 0.75 percent and the maximum design slope would be 1.25 percent.

- (e) Culvert outlet and inlet protection shall be used as necessary to reduce the risk of scour and perching.
- (f) Stream crossings shall be composed of a single pipe or arch for the main stream channel.
- (g) Overflow culverts may be used but should be placed at a higher elevation so that flows up to the OHWM pass through the primary culvert.
- (h) Stream crossings shall maintain the connectivity of wetlands adjacent to stream channels and shall accommodate sheet flow within such wetlands.
- (i) Stream crossing culverts shall not interfere with the functioning of floodplains and shall be designed to convey the design peak flow required by Table D-1. If the stream crossing culvert is not designed to accommodate the 100-year flow, a route must be established to safely convey flows exceeding the design peak flow without causing damage to property, endangering human life or public health, or causing significant environmental damage.
- (j) In cases of crossings within high entrenchment ratio environments, the ratio of the flood prone width to the OHWM width is greater than 2.2, floodplain overflow culverts may be beneficial to floodplain connectivity and can be used to pass the design flow. Minimum width requirements for the primary culvert still apply.
- (k) Stream crossing culverts shall have a minimum diameter of three feet.
- (l) Stream crossing culvert pipes and arches shall be metal.
- (m) Culverts longer than 100 feet require appropriate maintenance access and DPW approval
- (n) Install culverts in accordance with the manufacturer's recommendations for the anticipated traffic loads.

## **D06 Fish Passage Culverts**

These criteria provide general design guidance for road crossings of fish-bearing streams to maintain the full hydrologic functioning of the water body they are crossing. Site-specific conditions, such as multi-thread channels, may require alternate design approaches.

### **D06.1 Pre-design Conference**

Schedule a fish passage pre-design conference with DPW prior to permit submittals. The pre-design conference is to:

- (a) determine required permits;
- (b) coordinate interagency requirements;
- (c) determine any site-specific design requirements; and
- (d) establish a plan review process.

### **D06.2 Stream Simulation Method**

Stream simulation methodologies shall be used for the design of all fish-bearing stream crossings. The stream simulation method uses reference data from a representative section, or reference reach, of the specific water body crossed. This method attempts to replicate the natural stream channel conditions found upstream and downstream of the crossing. Sediment transport, flood and debris conveyance, and fish passage are designed to function as they do in the natural channel.

### **Reference Reach**

- (a) Select a reference reach on the water body being crossed that is outside any anthropogenic influence, such as an existing culvert. In most cases of new crossings, the reference reach can be at the crossing location.
- (b) The length of the reference reach should be a minimum of 20 times the reference bankfull width and no less than 200 feet.
- (c) If there is not a suitable reference reach on the water body being crossed, a reference reach may be chosen from another water body with similar geomorphic and hydrologic characteristics. The reference reach characteristics should meet the following criteria in comparison to the water body being crossed:
  - (1) The reference reach bankfull width should be at least one half and no more than two times that of the water body being crossed;
  - (2) The reference reach bankfull discharge should be at least one half and no more than one and one half times the bankfull discharge of the water body being crossed; and
  - (3) The stream order of the reference reach should be within one stream order of the water body being crossed.
- (d) For a reference reach from another water body, the geomorphic characteristics of the crossing shall be scaled using ratios of the bankfull conditions.
- (e) The reference reach bankfull dimensions should be determined in the field by surveying a detailed cross section at the upper 1/3 of a representative riffle.
- (f) Reference data shall include, at a minimum:
  - (1) channel width at the OHWM,
  - (2) bankfull width,
  - (3) bankfull cross-sectional area,
  - (4) bankfull slope based on the longitudinal profile,
  - (5) substrate, and
  - (6) potential for floating debris.

### **Culvert Size, Slope, and Substrate**

In addition to D05.2, the following criteria apply to fish passage culverts:

- (a) Under normal flow conditions, the channel within or under the fish passage culvert shall not differ from the reference reach condition in regards to the channel width at the OHWM, cross-sectional area, slope, substrate, and ability to pass floating debris.
- (b) The width of fish passage culverts shall not be less than the greater of 1.2 times the channel width at the OHWM and 1.0 times the bankfull width.
- (c) Fish passage culverts shall have a minimum diameter of five feet.
- (d) The use of smooth wall culverts is prohibited.
- (e) The use of trash racks or debris interceptors is prohibited
- (f) Round culvert pipes shall have a minimum invert burial depth of 40 percent of the culvert diameter into the substrate. Arch or box culverts shall have a minimum invert burial depth of 20

percent of the culvert's rise into the substrate, unless scour analysis shows less fill is acceptable. The minimum invert burial depth is 1 foot.

- (g) The gradation of the substrate material within a fish passage culvert shall be designed to be a dense, well-graded mixture with adequate fines to ensure that the majority of the stream flows on the surface and the minimum water depth is maintained.
- (h) Substrate material within or under the fish passage culvert shall remain dynamically stable at all flood discharges up to and including a 50-year flood. Dynamic stability means that substrate material mobilized at higher flows will be replaced by bed material from the natural channel upstream of the crossing. For crossings without an adequate upstream sediment supply, the substrate material within the crossing shall be designed to resist the predicted critical shear forces up to the 100-year flood. For culverts with a slope of 6 percent or greater, substrate retention sills may be required to allow the bed load to continuously recruit within the culvert.
- (i) Substrate material within or under the fish passage culvert shall incorporate a low flow channel. The low flow channel should mimic the reference reach where possible. If the low flow channel dimensions are not discernable from the reference reach, the low flow channel should have a cross sectional area of 15 to 30 percent of the bankfull cross sectional area and a minimum depth of 4 inches for juvenile fish and 12 inches for adult fish. The low flow channel should be defined by rock features that will resist critical shear forces up to the 100-year flood.
- (j) Constructed streambanks are recommended inside fish passage culverts to protect the culvert from abrasion, provide resting areas for fish, and provide for small mammal crossing. If streambanks are constructed through a crossing, the streambanks shall be constructed of rock substrate designed to be stable at the 100-year flood. The streambank width should be a minimum of 1.5 times the maximum sieve size of the streambed material (D100). The crossing width shall be increased to allow for the channel width plus the streambanks.
- (k) If substrate retention sills are used, they shall have a maximum weir height of one half of the culvert invert burial depth. Substrate retention sills shall be spaced so that the maximum drop between weirs is 4 inches. The use of sills without substrate is not allowed.
- (l) Other state and federal requirements may apply.

### D06.3 Hydraulic Method

Hydraulically designed culverts are discouraged for fish-bearing stream crossings, though may be approved by DPW and ADFG in circumstances where stream simulation is not practical. In addition to D05.2, the following criteria apply to hydraulically designed culverts:

- (a) The hydraulic method uses the swimming capability and migration timing of target design species and sizes of fish to create favorable hydraulic conditions throughout the culvert crossing. Information and design software for this methodology is available from ADFG, Division of Sport Fisheries (Fishpass) and the US Forest Service (FishXing).
- (b) The design fish shall be a 55-milimeter (2.16-inch) juvenile coho salmon for anadromous streams and a 55-milimeter (2.16-inch) Dolly Varden char for non-anadromous streams. These criteria may change based on ongoing research by federal and state agencies.

- (c) Fish passage high flow design discharge will not exceed the 5 percent annual exceedance flow or 0.4 times the 2-year peak flow, whichever is lower and has the most supporting hydrologic data.
- (d) Fish passage low-flow design discharge shall ensure a minimum 6-inch water depth or natural low flow and depth within the reach the crossing occurs. In cases where local conditions preclude natural low flow characteristics, backwatering or in-culvert structures should be considered.
- (e) In cases where flared end sections with aprons are necessary and fish passage is required, water depths and velocities that satisfy fish passage criteria must be demonstrated across the apron in addition to within the culvert.
- (f) Fish passage criteria for culverts crossing tidally-influenced streams must be satisfied 90 percent of the time. Tidally-influenced streams may sometimes be impassable due to insufficient depth at low flow and low tide. If the tidal area immediately downstream of a culvert is impassable for fish at low tide, the exceedance criterion shall apply only to the time during which fish can swim to the culvert.
- (g) Other state and federal requirements may apply.

## D07 Rainfall Data

### D07.1 Rainfall Distribution

The following IDF curves and hyetograph, derived from data measured at the Palmer airport, may be used for runoff calculations.

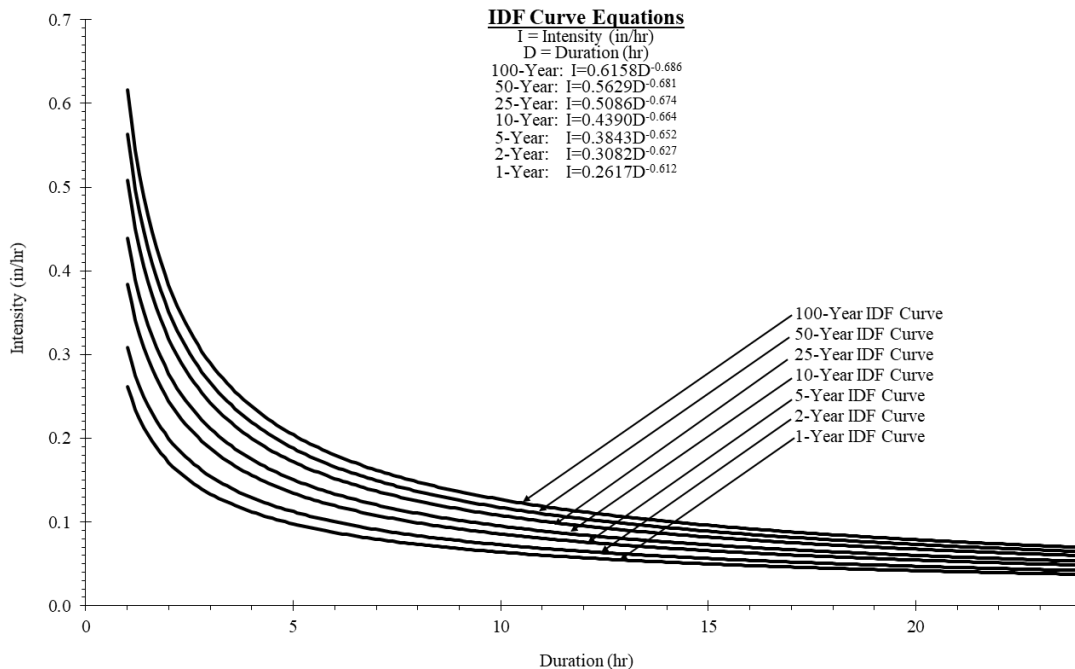

Figure D-1: Intensity-Duration-Frequency Relationships for the Matanuska-Susitna Borough

Source: Palmer Municipal Airport, 1999 to 2008, Stantec – 2009

Table D-2: Recurrence Interval Hyetographs (in/hr) for the Matanuska-Susitna Borough

Time (hr)	1 Year	2 Year	5 Year	10 Year	25 Year	50 Year	100 Year
1	0.01	0.02	0.02	0.02	0.02	0.02	0.02
2	0.02	0.02	0.02	0.02	0.02	0.02	0.02
3	0.02	0.02	0.02	0.02	0.02	0.02	0.03
4	0.02	0.02	0.02	0.02	0.02	0.03	0.03
5	0.02	0.02	0.02	0.02	0.03	0.03	0.03
6	0.02	0.02	0.02	0.03	0.03	0.03	0.03
7	0.02	0.02	0.03	0.03	0.03	0.03	0.04
8	0.03	0.03	0.03	0.03	0.04	0.04	0.04
9	0.03	0.03	0.04	0.04	0.04	0.05	0.05
10	0.04	0.04	0.04	0.05	0.05	0.06	0.06
11	0.05	0.05	0.06	0.06	0.07	0.08	0.08
12	0.06	0.07	0.07	0.08	0.09	0.10	0.10
13	0.26	0.31	0.38	0.44	0.51	0.56	0.62
14	0.08	0.09	0.10	0.12	0.13	0.14	0.15
15	0.04	0.04	0.05	0.05	0.06	0.06	0.07
16	0.03	0.04	0.04	0.04	0.05	0.05	0.05
17	0.03	0.03	0.03	0.04	0.04	0.04	0.04
18	0.02	0.03	0.03	0.03	0.03	0.04	0.04
19	0.02	0.02	0.03	0.03	0.03	0.03	0.03
20	0.02	0.02	0.02	0.02	0.03	0.03	0.03
21	0.02	0.02	0.02	0.02	0.03	0.03	0.03
22	0.02	0.02	0.02	0.02	0.02	0.02	0.03
23	0.02	0.02	0.02	0.02	0.02	0.02	0.02
24	0.02	0.02	0.02	0.02	0.02	0.02	0.02
Total	0.90	1.01	1.16	1.28	1.43	1.55	1.67

Note: Total values of rainfall calculated by adding un-rounded average rainfall intensities for each time step.

Source: Palmer Municipal Airport, 1999 to 2008, Stantec – 2009

## Section E. Easements

### E01 General

#### E01.1 Common Access Easements

When a shared driveway is required for two or more lots, a common access easement shall be dedicated for the exclusive use of the subject lots, unless otherwise accommodated. The MSB is the permitting authority within common access easements. The common access easement shall be sized to reasonably accommodate separation of the shared driveway to the individual lots.

#### E01.2 Drainage Easements

Drainage easements are required where the ROW is not sufficient to accommodate drainage needs. Drainage easements can overlap with other platted easements and shall begin or terminate at the ROW. Drainage easements shall be a minimum width of 20 feet, and a minimum average length of 20 feet outside of any overlapping easements or of sufficient size and area shown to facilitate construction and maintenance.

#### E01.3 Slope Easements

Slope easements are required to contain all cut and fill slopes steeper than 2.5:1 that extend outside of the ROW, plus at least 5 feet outside the cut or fill catches.

#### E01.4 Sight Distance Maintenance Easements

Sight distance maintenance easements are required where intersection sight triangles extend outside of the ROW.

#### E01.5 Snow Storage Easements

Snow storage easements are required where the ROW is not sufficient to accommodate anticipated snow removal needs. Snow storage easements shall be located where the storage of snow would not impede sight distance.

#### E01.6 Utility Easements

Unless lots are otherwise served by alternate utility easements or agreements, at least one 15-foot utility easement adjacent to the ROW is required to allow for utility installation and maintenance. Additional utility easements may be required as deemed reasonably necessary by utility companies to serve the subdivision or protect existing facilities. The applicant is responsible for satisfying any conflicts that may occur in the request for easements from any utility company during the platting process.

Platted utility easements are to be clear of wells, septic systems, structures, or encroachments, as defined by MSB or other applicable code; unless the applicant has obtained an encroachment permit from the MSB and a "Non-Objection to Easement Encroachment" from each utility.

Utility easements are to be fully useable for utility installation where installation equipment can safely work. Whenever possible, utility easements should not be placed in swamps, steep slopes, or other unusable areas.



## Section F. Development Implementation

### F01 General

This section describes the procedure that is to be followed before constructing any improvements required for recording a subdivision plat. The applicant's engineer shall be the primary point of contact throughout this process.

It is the applicant's responsibility to determine, acquire, and follow permits required by other agencies. Approval from MSB does not supersede other agencies' permit requirements.

#### F01.1 Preliminary Plat Submittal

The preliminary plat submittal is to be accompanied by:

- (a) ADT calculations per A15;
- (b) Preliminary drainage plan per D02.1;
- (c) Road plan and profile for sections of road where proposed grades exceed 6 percent where cuts and fills exceed 5 feet in height measured from the centerline, or where slope easements will be required, and cross sections at the maximum cut and fill sections. Road plan and profile shall include the vertical curves or grade breaks on either side of the subject sections;
- (d) Road plan, profile, and cross-sections if required by B03.3; and
- (e) Intersection sight distance evaluation, if requested, according to A09.1.

#### F01.2 Construction Plans

Submit construction plans to DPW at least seven calendar days before the preconstruction conference. All plan drawing submittals shall be at a scale of 1 inch = 50 feet or more detailed, plottable on 11" by 17" paper. Construction plans shall include the following:

- (a) Drainage Report, according to D02.2;
- (b) Plan & Profile of proposed roads (if required by F01.1);
  - (1) Existing topography with horizontal and vertical accuracy meeting US National Map Accuracy standards, two-foot contour intervals within the proposed road corridors.
- (c) Asbuilt survey of visible improvements and above ground utilities within and adjacent to the subdivision;
- (d) Copy of agency accepted permit applications required for the improvements prior to construction, including but not limited to ADOT&PF Approach Road Permit, DNR Section Line Easement authorization, MSB Flood Hazard Development permit, and USACE wetland fill permit; and
- (e) Plans for any proposed improvements within the ROW that are outside of the scope of this manual (e.g. retaining walls or guard rail) or do not conform to the standards set forth herein, conforming to ADOT&PF design criteria and standards.

### F01.3 Preconstruction Conference

The preconstruction conference is for the purpose of reviewing and approving the Subdivision Construction Plan for the required improvements. The engineer may request scheduling of a preconstruction conference with DPW after the preliminary plat has been approved by the Platting Board, the Notification of Action (NOA) has been received, and the construction plans have been submitted. Scheduling of preconstruction conference requests may be delayed during the month of October. The applicant, or designated representative, and the engineer must attend the preconstruction conference. In addition to the construction plans, the following items will be provided at or prior to the preconstruction conference:

- (a) Cost estimate of required improvements for the determination of the inspection fee according to the most recently adopted Schedule of Rates and Fees;
- (b) Proof of compliance with the Alaska Pollutant Discharge Elimination System Program;
  - (1) Acceptable proof includes a Notice of Intent (NOI), a Low Erosivity Waiver (LEW), or a determination by a qualified person that neither is needed.
- (c) Rough plan and time line for construction;
- (d) Copy of any issued permits required for the improvements prior to construction;
- (e) Off-site material source and quantities; and
- (f) On-site clearing, grubbing, and topsoil disposal plan, location map.

The Subdivision Construction Plan must be signed by the applicant, or designated representative, and the engineer. Upon acceptance of the Subdivision Construction Plan by DPW and payment of the inspection fee, the Platting Division will issue a Notice to Proceed (NTP). See Appendix B for an example of the Subdivision Construction Plan.

Some construction plans or permit approvals may take longer to develop or obtain, such as fish passage culvert plans and associated permits. Those finalized plans and issued permits may be submitted later but must be received and reviewed by DPW before construction begins within the respective areas.

### F01.4 Interim Inspections

The applicant's engineer shall supervise all phases of construction. Notify DPW of changes to the Subdivision Construction Plan, such as adding or deleting a cross culvert, changes in culvert size, adding or deleting a drainage facility, grade changes of more than 1 percent or that would result in grades of over 6 percent or cuts or fills of over 5 feet in height measured from the centerline, or changes to foreslopes or backslopes. The changes should be approved by DPW prior to completion of construction. Periodic interim inspections may be conducted by DPW. Interim inspections may be requested by the engineer.

### F01.5 Pre-Final Inspection

When the engineer has determined that construction of the improvements will be substantially complete according to the Subdivision Construction Plan, the engineer will request a Pre-Final Inspection. The Pre-Final Inspection request must be received by September 30<sup>th</sup> and shall include a

description of work yet to be completed. The Pre-Final Inspection will be scheduled to occur within 14 calendar days of the request and shall be attended by the engineer and DPW. A punch list will be developed, if any work items remain, at the Pre-Final Inspection.

#### F01.6 Final Inspection

When construction of the improvements and punch list items are complete according to the Subdivision Construction Plan, the engineer will request a Final Inspection of the improvements. The Final Inspection request must be received by October 15<sup>th</sup>. Final Inspections will cease October 31<sup>st</sup>, or when winter conditions prohibit inspection, whichever comes first. The Final Inspection will be scheduled to occur within 14 calendar days of the request and shall be attended by the engineer and DPW.

#### F01.7 Final Report

Upon DPW approval of the Final Inspection, the engineer shall submit a written Final Report to the Platting Division. The Final Report shall include:

- (a) Stamped and signed narrative describing at a minimum:
  - (1) road construction process and equipment used,
  - (2) material source and disposal areas,
  - (3) road embankment and subbase used,
  - (4) road topping or pavement used,
  - (5) compactive effort,
  - (6) road dimensions and shaping (length, roadway width, material thicknesses, pavement width, crown, cul-de-sac or t-turnaround dimensions and slope, foreslope, backslope, maximum centerline grade, etc.) for each road constructed,
  - (7) drainage, ditch depth, location of drainage easements, and
  - (8) road standard certification (Pioneer Road, Residential Street, etc.) for each road constructed;
- (b) Stamped and signed final drainage plan, (minimum 11"x17");
- (c) As-built drawing showing the horizontal locations of borrow extraction along the road corridor;
- (d) Compaction test reports;
- (e) Gradation tests, if required; and
- (f) Photos of each stage of construction.

DPW will review the report and provide comments, if necessary, within 14 calendar days.

#### F01.8 Construction Acceptance

Upon approval of the Final Report, DPW will issue a Certificate of Construction Acceptance.

#### F01.9 Warranty

All improvements are to be guaranteed until October 31<sup>st</sup> of the calendar year following issuance of the Certificate of Construction Acceptance. Roads within a Road Service Area may be accepted for

maintenance at the end of the warranty. Pioneer Roads are not eligible for maintenance. Maintenance of Mountain Access Roads is at the discretion of DPW.

During the warranty period, the applicant is responsible for any road maintenance including, but not limited to: snow removal, maintaining a smooth road surface and crown, maintaining stabilized foreslopes and backslopes, and maintaining positive drainage. If any deficiencies arise during the warranty, DPW will issue a punch list to the applicant by September 1<sup>st</sup> to allow time for completion of repairs. The applicant must notify DPW of completion of repairs by October 15<sup>th</sup> for the roads to be eligible for maintenance on November 1<sup>st</sup>.

The warranty period for improvements following completion of a subdivision agreement may be lessened to one calendar year. The applicant shall request a punch list from DPW no more than one month before the end of the one-year warranty.

If the subdivision plat has not recorded within 6 months of the date of the Certificate of Construction Acceptance or if warranty repairs are not completed by October 15<sup>th</sup>, the warranty will be extended an additional year and the warranty process will be repeated.

Maintenance may be denied and the Certificate of Construction Acceptance revoked if deficiencies are not corrected to the satisfaction of DPW. A notice may be recorded indicating to the public that the MSB is not responsible for road upkeep and maintenance until such a time that the deficiencies are corrected.

## **Section G. Commercial and Industrial Subdivisions**

### **G01 General**

Commercial and Industrial subdivisions shall be designed using trip generation rates from the Institute of Transportation Engineers (ITE) Trip Generation Manual, and to meet the standards of AASHTO, International Fire Code (IFC), and any other applicable standards or code.

## Section H. Utilities

### H01 General

These standards apply to the design and construction of utility facilities within the MSB. All utility installation within existing or proposed ROW or utility easements must comply with the provisions of MSB or other applicable code, or as otherwise approved by the permitting authority.

### H02 Utility Location Guidelines

#### H02.1 Underground Utility Facilities:

- (a) The location of utility facilities placed within the ROW shall be coordinated with the permitting authority.
- (b) Backslopes or foreslopes which extend into a utility easement should not exceed 4:1. These limits are necessary for construction equipment for utility installation.
- (c) Utility facilities paralleling the road shall not be located within 10 feet of the roadway, unless otherwise approved by the permitting authority.
- (d) Underground road crossings shall be buried a minimum of 48 inches below finished grade. Backfill shall be compacted according to the requirements of Section C, or as otherwise approved by the permitting authority.
- (e) Conduit road crossings, if used, shall be installed in accordance with each utility company's standards and applicable code.
- (f) Standard burial depth of longitudinal utilities is 36 inches below grade. The applicant should delineate areas, such as where driveways and drainage easements are planned, where deeper burial may be needed.

#### H02.2 Above Ground Utility Facilities:

- (a) Above ground pedestals, poles, and utility facilities shall not be located within 10 feet of the roadway, unless an alternate design meets clear zone requirements.
- (b) Above ground pedestals, poles, and utility facilities shall not be located such that they substantially block intersection or driveway sight triangles.
- (c) Unless otherwise authorized by the permitting authority, above ground pedestals, poles, and utility facilities shall not be located within the ROW nearer than 40 feet from the point of intersection of the extension of the property lines at any existing or proposed intersection on Residential Collector streets or higher classification.
- (d) Above ground pedestals, poles, and utility facilities shall not be located within a common access easement or drainage easement, within 20 feet of a common access point, or within 10 feet of a roadway cross culvert.
- (e) Permanent 5-foot high snow marker poles, grey with white retroreflective sheeting or yellow, shall be installed on all pedestals and vaults.
- (f) All guy wires installed within the ROW or utility easements adjacent to, or near to a roadway shall have a minimum 8-foot long yellow delineator installed above the anchor.

- (g) Pedestals located within the ROW shall be located within the outer 1 foot of the ROW.

### H02.3 Separation of Utilities:

- (a) Recommend 5-foot horizontal separation between power poles and buried utilities.
- (b) Recommend minimum 1-foot physical separation between all underground utilities.
- (c) Separation of storm, sewer, and water utilities shall meet the requirements of the Alaska Department of Environmental Conservation.

## References

- American Association of State Highway and Transportation Officials. (2018). *A Policy on Geometric Design of Highways and Streets* (7<sup>th</sup> ed.). Washington, DC.
- American Association of State Highway and Transportation Officials. (2011). *Roadside Design Guide* (4<sup>th</sup> ed.). Washington, DC.
- American Association of State Highway and Transportation Officials. (2017). *Guide for the Development of Bicycle Facilities* (4<sup>th</sup> ed.). Washington, DC.
- Alaska Department of Transportation & Public Facilities. (2019). *Alaska Highway Preconstruction Manual*. Juneau, AK.
- Alaska Department of Transportation & Public Facilities. (2017). *Alaska Standard Specifications for Highway Construction* (2017 ed.). Juneau, AK.
- Alaska Department of Transportation & Public Facilities. (2015). *Alaska Sign Design Specifications*. Juneau, AK.
- Alaska Department of Transportation & Public Facilities. (2007). *Alaska Test Methods Manual*. Juneau, AK.
- Alaska Department of Transportation & Public Facilities. (2016). *Alaska Traffic Manual*. Juneau, AK.
- Alaska Railroad. (1988). *Alaska Policy on Railroad/Highway Crossings*. Anchorage, AK.
- Alaska Society of Professional Land Surveyors. (2013). *Standards of Practice Manual*. (4<sup>th</sup> ed.). Anchorage, AK.
- Institute of Transportation Engineers. (2017). *Trip Generation Manual*. (10<sup>th</sup> ed.). Washington, DC.
- Matanuska-Susitna Borough. (2017). *Matanuska-Susitna Borough Long Range Transportation Plan*. Palmer, AK.
- Matanuska-Susitna Borough. (1997). *Matanuska-Susitna Borough Official Streets and Highway Plan*. Palmer, AK.
- Matanuska-Susitna Borough. (2019). *Matanuska-Susitna Borough Standard Modifications to State of Alaska Standard Specification for Highway Construction* (2017 ed.). Palmer, AK.
- U.S. Department of Transportation Federal Highway Administration. (2012). *Manual of Uniform Traffic Control Devices for Streets and Highways* (2009 ed. with 2012 revisions). Washington, DC.



## **Appendix A**

MSB Special Provision to the ADOT&PF Standard Specifications for Highway Construction

## APPENDIX A

### SECTION 401

#### HOT MIX ASPHALT PAVEMENT

Special Provision

Replace Section 401 with the following:

**401-1.01 DESCRIPTION.** Construct one or more courses of plant-produced Hot Mix Asphalt (HMA) pavement on an approved surface, to the lines, grades, and depths described in the scope of work and shown on the maps at each location.

#### MATERIALS

**401-2.01 ASPHALT BINDER.** Conform to Subsection 702-2.01. If binder performance grade is not specified, use PG 52-28. Asphalt binder may be conditionally accepted at the source if a manufacturer's certification of compliance is provided, according to Subsection 106-1.05, and the applicable requirements of Section 702 are met.

**401-2.02 LIQUID ANTI-STRIP ADDITIVE.** Use anti-strip agents in the proportions determined by ATM 414 and included in the approved Job Mix Design (JMD). At least 70 percent of the aggregate must remain coated when tested according to ATM 414. A minimum of 0.30 percent by weight of asphalt binder is required.

**401-2.03 JOINT ADHESIVE.** Conform to Subsection 702-2.05.

**401-2.04 JOINT SEALANT.** Conform to Subsection 702-2.06.

**401-2.05 WARM MIX ASPHALT.** Conform to Subsection 702-2.07.

**401-2.06 ASPHALT RELEASE AGENT.** Conform to Subsection 702-2.08.

**401-2.07 AGGREGATES.** Conform to Subsection 703-2.04. Use a minimum of three stockpiles of crushed aggregate (coarse, intermediate, and fine). Place blend material, if any, in a fourth pile.

**401-2.08 RECYCLED ASPHALT PAVEMENT.** Recycled asphalt pavement (RAP) may be used in the production of HMA. The RAP may be from pavements removed under the Contract, or from an existing stockpile. Conform to Subsection 703-2.16

**401-2.09 JOB MIX DESIGN.** Provide target values for gradation that satisfy both the broad band gradation limits shown in Table 703-4 and the requirements of Table 401-1, for Type II, Class B HMA.

**TABLE 401-1**

**HMA MARSHALL DESIGN REQUIREMENTS**

<b>DESIGN PARAMETER</b>	<b>CLASS "B"</b>
HMA (including Asphalt Binder)	
Stability, Pounds	1200 Min
Flow, 0.01 Inch	8 – 16
Voids in Total Mix (VTM), %	3.0 – 5.0
Compaction, Number of Blows Each Side of Test Specimen	50
Asphalt Binder	
Voids Filled with Asphalt (VFA), %	65 – 78
Asphalt Content, Min %	5.0
Dust-Asphalt Ratio*	0.6 – 1.4
Voids in Mineral Aggregate (VMA), %, Min	12.0
Liquid Anti-Strip Additive**, %, Min	0.30
RAP, %, Max	25.0

\*Dust-Asphalt ratio is the percent of material passing the No. 200 sieve divided by the percent of effective asphalt binder (calculated by weight).

\*\*By Weight of Asphalt Binder

The Contractor shall provide a JMD following the requirements specified in this section. Submit the JMD to the Engineer at least two working days prior to the pre-paving meeting. Submit samples to the Engineer upon request for JMD verification testing.

All Contractor-furnished JMDs must be sealed by a Professional Engineer registered in the State of Alaska. The Professional Engineer shall certify that the JMD was performed according to the specified procedures, and meets all project specifications.

Changes in the source of asphalt binder, source of aggregates, aggregate quality, aggregate gradation, or blend ratio shall dictate that the Contractor submit a new JMD for approval.

**CONSTRUCTION REQUIREMENTS**

**401-3.01 PRE-PAVING MEETING.** Meet with the Engineer for a pre-paving meeting in the presence of project superintendent and paving supervisor at least five (5) working days before beginning paving operations. Submit a paving plan and pavement inspection plan at the meeting. When directed by the Engineer, make adjustments to the plan and resubmit.

Include the following elements in the paving plan and address these elements at the meeting:

- a. Sequence of operations
- b. List of equipment that will be used for production, transport, pick-up (if applicable), laydown, and compaction
- c. Procedures to produce consistent HMA
- d. Procedures to minimize material and thermal segregation

- e. Procedures to minimize premature cooling
- f. Procedures to achieve HMA density
- g. Procedures for joint construction including corrective action for joints that do not meet surface tolerance requirements
- h. Quality control testing methods, frequencies, and sample locations for gradation, asphalt binder content, and density, and
- i. Any other information or procedures necessary to provide completed HMA construction that meets the contract requirements.

Include the following elements in the pavement inspection plan and address these elements at the meeting:

- a. Process for daily inspection, and
- b. Means and methods to remove and dispose of project materials.

**401-3.02 CONTRACTOR QUALITY CONTROL.** Perform quality control (QC) of HMA materials in accordance with Subsection 106-1.03. The Contractor shall employ a qualified person or company to perform process control testing.

**401-3.03 WEATHER LIMITATIONS.** Place HMA on a stable and non-yielding roadbed. Do not place HMA when the base material is wet or frozen, or when weather conditions prevent proper handling or finishing of the mix. Do not place HMA leveling course when the roadway surface temperature is colder than 40° F.

**401-3.04 EQUIPMENT, GENERAL.** Use equipment in good working order and free of HMA buildup. Make all equipment available for inspection and demonstration of operation a minimum of 24 hours before placement of HMA and test strip HMA.

**401-3.05 ASPHALT MIXING PLANT.** Meet AASHTO M 156. Use an HMA plant capable of producing at least 100 tons of HMA per hour noted on posted DEC air quality permit, designed to dry aggregates, maintain consistent and accurate temperature control, and accurately proportion asphalt binder and aggregates. Calibrate the HMA plant and furnish copies of the calibration data to the Engineer at least 24 hours before HMA production.

Provide a scalping screen at the asphalt plant to prevent oversize material or debris from being incorporated into the HMA.

Provide a tap on the asphalt binder supply line just before it enters the plant (after the 3-way valve) for sampling asphalt binder. Provide aggregate and asphalt binder sampling locations meeting OSHA safety requirements.

Belt conveyor scales may be used to proportion plant blends and mixtures if the scales meet the general requirements for weighing equipment and are calibrated according to the manufacturer's instructions.

**401-3.06 HAULING EQUIPMENT.** Haul HMA in trucks with tight, clean, smooth metal beds. Keep beds free of petroleum oils, solvents, or other materials that would adversely affect the mixture. Apply a thin coat of approved asphalt release agent to beds as necessary to prevent mixture adherence. Provide

trucks with covers attached and available for use. When directed by the Engineer, cover the HMA in the hauling vehicle(s).

Do not haul HMA on barges.

**401-3.07 ASPHALT PAVERS.** Use self-propelled asphalt pavers with heated vibratory screed assemblies to spread and finish HMA to the specified section widths and thicknesses without introducing thermal or material segregation.

Equip the paver with a receiving hopper having sufficient capacity for a uniform spreading operation and a distribution system to place the HMA uniformly in front of screed. Use a screed assembly that produces a finished surface of the required smoothness, thickness, and texture without tearing, shoving, or displacing the HMA. Heat and vibrate screed extensions. Place auger extensions within 20 inches of the screed extensions or per written manufacturer's recommendations.

Equip the paver with a means of preventing segregation of the coarse aggregate particles from the remainder of the HMA when carried from the paver hopper back to the augers.

The use of a "Layton Box" or equivalent towed paver is allowed on bike paths, sidewalks, and driveways.

**401-3.08 ROLLERS.** Use both steel-wheel (static or vibratory) and pneumatic-tire rollers. Use rollers designed to compact HMA and capable of reversing without shoving or tearing the mixture. Select rollers that will not crush the aggregate or displace the HMA. Equip vibratory rollers with separate vibration and propulsion controls.

Equip the rollers with an infrared thermometer that measures and displays the surface temperature to the operator. Infrared thermometer may be hand-held or fixed to the roller.

Utilize a pneumatic roller in the complement of rollers to compact the leveling course. Use fully skirted pneumatic-tire roller having a minimum operating weight of 3000 pounds per tire.

**401-3.09 RESERVED.**

**401-3.10 PREPARATION OF EXISTING SURFACE.** Prepare existing surfaces according to the Contract. Prior to placing HMA, clean existing surfaces of loose material and uniformly coat contact surfaces of curbing, gutters, manholes and other structures with tack coat material meeting Section 402. Treat cold joint surfaces according to 401-3.17. Allow tack coat to break before placement of HMA on these surfaces.

Cut existing pavement, as designated by the Engineer, in a neat line with a power driven saw to provide a clean, straight joint. A thin tack coat of asphalt binder shall be sprayed on all cold joints prior to placing any fresh HMA against the joint. Cutting and removing the asphalt and tack coat is subsidiary to 401(1) item.

Before applying tack coat to an existing paved surface, clean and patch the surface. Remove irregularities to provide a reasonably smooth and uniform surface. Remove and replace unstable areas with HMA. Clean the edges of existing pavements, which are to be adjacent to new pavement, to permit

the adhesion of asphalt materials. Clean loose material from cracks. Fill the cleaned cracks, wider than 1 inch, with HMA tamped in place. Wash, sweep, or wash and sweep the paved surface clean and free of loose materials.

Preparation of a milled surface:

1. Prelevel remaining ruts, pavement delaminations, and depressions having a depth greater than 1/2 inch with an approved HMA.
2. Notify the Engineer of pavement areas that appear thin or unstable. Where milling operation creates thin or unstable pavement areas, or where it breaks through existing pavement, remove thin and unstable pavement, and 2 inches of existing base material, compact and replace with an approved HMA.

**401-3.11 PREPARATION OF ASPHALT.** Provide a continuous supply of asphalt binder to the asphalt mixing plant at a uniform temperature, within the recommended mixing temperature range.

**401-3.12 PREPARATION OF AGGREGATES.** Dry the aggregate so the moisture content of the HMA, sampled at the point of acceptance for asphalt binder content, does not exceed 0.5 percent (by total weight of mix), as determined by ATM 407.

Heat the aggregate for the HMA to a temperature compatible with the mix requirements specified.

Adjust the burner on the dryer to avoid damage to the aggregate and to prevent the presence of unburned fuel on the aggregate. HMA containing soot or fuel is unacceptable per Subsection 105-1.11.

**401-3.13 MIXING.** Combine the aggregate, asphalt binder, and additives in the mixer in the amounts required by the JMD. Mix to obtain at least 98 percent coated particles when tested according to AASHTO T195.

For batch plants, put the dry aggregate in motion before addition of asphalt binder.

Mix the HMA within the temperature range determined by the JMD.

Upon the Engineer's request, provide daily burner charts showing start and stop times and temperatures.

**401-3.14 TEMPORARY STORAGE OF HMA.** Silo type storage bins may be used, provided the characteristics of the HMA remain unaltered.

Signs of visible segregation, heat loss, changes from the JMD, change in the characteristics of asphalt binder, lumpiness, and stiffness of the mixture, are causes for rejection.

Do not store HMA on barges.

**401-3.15 PLACING AND SPREADING.** Use asphalt pavers to distribute HMA, including leveling course and temporary HMA. Place the HMA upon the approved surface, spread, strike off, and adjust surface irregularities. The maximum compacted lift thickness allowed is 3 inches.

When multiple lifts are specified in the Contract, do not place the final lift until all lower lifts throughout that section, are placed and accepted.

Do not place HMA abutting curb and gutter until curb and gutter are installed, except as approved by the Engineer.

Do not pave against new Portland cement concrete curbing until it has cured for at least 72 hours.

When practicable, adjust elevation of metal fixtures before paving the final lift, so they will be between 1/4 and 1/2 inch below the top surface of the final lift. Metal fixtures include, but are not limited to manholes, valve boxes, monument cases, hand holes, and drains.

When the section of roadway being paved is open to traffic, pave adjacent traffic lanes to the same elevation within 24 hours. Place approved material against the outside pavement edge when the drop off exceeds 2 inches.

Use hand tools to spread, rake, and lute the HMA in areas where irregularities or unavoidable obstacles make mechanical spreading and finishing equipment impracticable.

Place HMA over bridge deck membranes according to Section 508 and the membrane manufacturer's recommendations.

Do not mix HMA produced from different plants for testing or paving.

**401-3.16 COMPACTION.** Thoroughly and uniformly, compact the HMA by rolling. In areas not accessible to large rollers, compact with mechanical tampers or trench rollers. Compact HMA immediately after it is placed and spread, and as soon as it can be compacted without undue displacement, cracking or shoving. Perform initial breakdown compaction while the HMA surface mixture temperature is greater than 235° F and finish compaction before the surface temperature reaches 150° F.

Prevent indentation in the mat, do not leave rollers or other equipment standing on HMA that has not sufficiently cooled.

The Lower Specification Limit for density is 92.0 percent of the Maximum Specific Gravity (MSG) as determined by ATM 409. The MSG from the approved JMD is used for the first lot of each type of HMA. The MSG for additional lots is determined from the first subplot of each lot.

**401-3.17 JOINTS.** Place and compact the HMA to provide a continuous bond, texture, and smoothness between adjacent sections of the HMA.

Minimize the number of joints. Do not construct longitudinal joints in the driving lanes unless approved by the Engineer in writing at the pre-paving meeting. Offset the longitudinal joints in one layer from the joint in the layer immediately below by at least 6 inches. Align the joints of the top layer at the centerline or lane lines. Where preformed marking tape striping is required, offset the longitudinal joint in the top layer not more than 6 inches from the edge of the stripe.

Form transverse joints by saw-cutting back on the previous run to expose the full depth of the course or by using a removable bulkhead. Skew transverse joints 15 to 25 degrees.

For all joints below the top lift, uniformly coat joint surfaces with tack coat material meeting Section 402.

Uniformly coat the joint face of all top lift joints with a joint adhesive. Follow joint adhesive manufacturer's recommendations for temperatures and application method. Remove joint adhesive applied to the top of pavement surface. If infrared joint heaters are used and passing joint densities are achieved in each of the first three joint densities taken, then joint adhesive is not required.

The Lower Specification Limit for top lift longitudinal joint density is 91.0 percent of the MSG of the panel completing the joint. MSG will be determined according to ATM 409. Top lift longitudinal joints will be evaluated for acceptance according to Subsection 401-4.03.

For top lift panels that have a longitudinal joint density less than 91.0 percent of the MSG, seal the surface of the longitudinal joints with joint sealant. Apply joint sealant according to the manufacturer's recommendations while the HMA is clean, free of moisture and prior to final traffic marking. Place the sealant at a maximum application rate of 0.15 gallons per square yard, and at least 12 inches wide centered on the longitudinal joint. After surface sealing, inlay by grinding pavement striping into the sealed HMA. Use grooving equipment that grinds a dry cut to groove the width, length, and thickness of the striping within the specified striping tolerances.

Correct improperly formed joints that result in surface irregularities according to a corrective action plan.

Complete all hot lapped joints while the mat temperature is over 230° F as measured by the Engineer, within 3 inches of the joint. Tack coat and joint adhesive are not required for hot lapped joints.

**401-3.18 SURFACE REQUIREMENTS AND TOLERANCE.** The finished surface of all HMA paving must match dimensions shown in the Contract for horizontal alignment and width, profile grade and elevation, crown slope, and pavement thickness. Water must drain across the pavement surface without ponding. The surface must have a uniform texture, without ridges, puddles, humps, depressions, and roller marks. The surface must not exhibit raveling, cracking, tearing, asphalt bleeding, or aggregate segregation. Leave no foreign material, uncoated aggregate, or oversize aggregate on the HMA surface.

The Engineer will test the finished surface after final rolling at selected locations using a 10-foot straightedge. The Engineer will identify pavement areas that deviate more than 3/16 inch from the straightedge, including joints, as defective work. Perform corrective work by removing and replacing, grinding, cold milling or infrared heating such areas as required. Do not surface patch. After the Contractor performs corrective work, the Engineer will retest the area. Submit correction methods to the Engineer for approval before correction work commences.

Perform corrective actions according to one of the following or by a method approved by the Engineer:

1. Diamond Grinding. If the required pavement thickness is not decreased by more than 1/4 inch, grind to the required surface tolerance and cross section. Remove and dispose of all waste



materials. Apply joint sealant and sand to exposed aggregates per the manufacturer's recommendations.

2. Overlaying. Mill or sawcut the existing pavement to provide a vertical transverse joint face to match the overlay to the existing pavement. Apply tack coat on the milled surface and joint adhesive to all vertical joints and overlay the full width of the underlying pavement surface. Use the same approved HMA for overlays. Place a minimum overlay thickness of 2.0 inches.
3. Mill and Fill. Mill the existing pavement to provide a vertical transverse joint face. Apply tack coat to the milled surface and joint adhesive to all vertical joints prior to inlaying new HMA to match the existing pavement. Use the same approved HMA. Place a minimum thickness of 2.0 inches.

**401-3.19 REPAIRING DEFECTIVE AREAS.** Remove HMA that is contaminated with foreign material, is segregated (determined visually or by testing), flushing, or bleeding asphalt. Remove and dispose defective HMA for the full thickness of the course. Cut the pavement so that edges are vertical and the sides are parallel to the direction of traffic. Coat edges with a tack coat according to Section 402. Place and compact fresh HMA so that compaction, grade, and smoothness requirements are met.

**401-3.20 ROADWAY MAINTENANCE.** Inspect daily according to pavement inspection plan. Remove and dispose of project materials incorrectly deposited on existing and new pavement surfaces inside and outside the project area including haul routes.

The Contractor is responsible for damage caused by not removing these materials and any damage to the roadway from the removal method(s).

Repair damage to the existing roadway that results from fugitive materials or their removal.

**401-3.21 TEMPERATURE REQUIREMENTS.** The Engineer may reject HMA that is mixed, hauled, spread and placed, or compacted at a temperature outside the temperature range determined by either the JMD, by a control test strip, or by the Specifications. Rejected HMA is deemed unacceptable according to Subsection 105-1.11. The Engineer will determine whether the unacceptable HMA shall either be corrected, or removed and replaced.

At the Engineer's discretion, the Contractor may be allowed to compact HMA that is already placed and spread but is outside the temperature range. If the compacted HMA fails the Engineer's tests for acceptance, it must be removed and replaced according to Subsection 105-1.11.

**401-3.22 SHOULDERS.** After the paving is complete, if the Engineer determines that the shoulder is too narrow, additional gravel, D-1 material, or both shall be brought in to widen the shoulder. The pavement shall be washed, swept, or both immediately following shoulder work. The haul, placement, and sweeping will be subsidiary to 301(1) item.

All pavement edges shall be backed with base course (D-1), surface course (E-1), or processed material graded flush with the pavement surface. This work shall be accomplished as directed by the Engineer after it is determined that the new HMA has cured sufficiently to avoid damaging the edge. Cul-de-sacs and other areas where a grader cannot reach shall be backed by hand raking. The pavement shall be washed, swept, or both immediately following this work. This work will be subsidiary to 401(1) item.

**401-4.01 METHOD OF MEASUREMENT.** Section 109 and the following:

1. Hot Mix Asphalt. HMA will be measured by the ton in accordance with Section 109, Measurement and Payment. HMA quantities on the bid form include a 10% contingency. Contractor will be required to monitor depth (yield) and waste to not exceed the 10% contingency. Contractor will not be compensated over the HMA amount listed on the bid form unless work is added by a field directive and issued by the Engineer. Asphalt binder, tack coat, and anti-stripping additive will not be measured separately for payment, but are included in the HMA pay item.
2. Leveling Course. By Lane-Station (12-foot width) or by weight. Asphalt binder, tack coat, and anti-stripping additive will not be measured separately for payment, but are included in the Leveling Course pay item.

**401-4.02 ACCEPTANCE SAMPLING AND TESTING.** HMA will be accepted for payment based on the Engineer's approval of the JMD, and placement and compaction of the HMA to the specified depth, finished surface requirements and tolerances. The Engineer reserves the right to perform any testing required in order to determine acceptance.

Sampling and testing include the following:

1. Asphalt Binder Content. HMA samples shall be taken randomly by the Contractor in the presence of the Engineer from behind the paver screed before initial compaction, or will be taken randomly by the Engineer from the windrow, according to ATM 402 or ATM 403, at the discretion of the Engineer. The location (behind the paver screed or windrow) will be determined at the pre-paving meeting. Random sampling locations will be determined by the Engineer.

Two separate samples will be taken, one for acceptance testing and one held in reserve for retesting if requested. Asphalt binder content will be determined according to ATM 405 or ATM 406, at the discretion of the Engineer.

2. Aggregate Gradation. Aggregates tested for gradation acceptance will have the full tolerances from Table 401-2 applied.
  - a. Drum Mix Plants. Samples will be taken from the combined aggregate cold feed conveyor via a diverter device, from the stopped conveyor belt or from the same location as samples for determination of asphalt binder content, at the discretion of the Engineer. Two separate samples will be taken, one for acceptance testing and one held in reserve for retesting if requested. The aggregate gradation for samples from the conveyer system will be determined according to ATM 304. For HMA samples, the gradation will be determined according to ATM 408 from the aggregate remaining after the ignition oven (ATM 406) has burned off the asphalt binder. Locate diverter devices for obtaining aggregate samples from drum mix plants on the conveyor system delivering combined aggregates into the drum. Divert aggregate from the full width of the conveyor system and maintain the diverter device to provide a representative sample of aggregate incorporated into the HMA.

- b. Batch Plants. Samples will be taken from dry batched aggregates according to ATM 301 or from the same location as samples for determination of asphalt binder content, at the discretion of the Engineer. Two separate samples will be taken, one for acceptance testing and one held in reserve for retesting if requested. The aggregate gradation for dry batch samples will be determined according to ATM 304. For HMA samples, the gradation will be determined according to ATM 408 from the aggregate remaining after the ignition oven (ATM 406) has burned off the asphalt binder.
3. Density. The Engineer will determine and mark the location(s) where the Contractor takes each core sample.
  - a. Mat Cores. The location(s) for taking core samples is determined using a set of random numbers (independent of asphalt binder and aggregate sampling set of random numbers) and the Engineer's judgment. Take no mat cores within 1 foot of a joint or edge. Core samples are not taken on bridge decks.
  - b. Longitudinal Joint Cores. The Engineer will mark the location(s) to take the core sample, centered on the visible surface joint, and adjacent to the mat core sample taken in the panel completing the joint.

Take core samples according to ATM 413 in the presence of the Engineer. Cut full depth core samples, centered on the marks and as noted above, from the finished HMA within 24 hours after final rolling. Neatly core drill one six-inch diameter sample at each marked location. Use a core extractor to remove the core - do not damage the core. The Engineer will immediately take possession of the samples. Backfill and compact voids left by coring with new HMA within 24 hours. The Engineer will determine density of samples according to ATM 410.

4. Retest. When test results have failed to meet specifications, retest of acceptance test results for asphalt binder content, gradation, and density may be requested provided the quality control requirements of Subsection 401-3.02 are met. Deliver this request in writing to the Engineer within 7 days of receipt of the final test of the lot. The Engineer will mark the sample location for the density retest within a 2-foot radius of the original core. The original test results are discarded and the retest result is used. Only one retest per sample is allowed. When gradation and asphalt binder content are determined from the same sample, a request for a retest of either gradation or asphalt binder content results in a retest of both.
5. Asphalt Binder Grade. The lot size for asphalt binder is 200 tons. If a project has more than one lot and the remaining asphalt binder quantity is less than 150 tons, it is added to the previous lot and that total quantity will be evaluated as one lot. If the remaining asphalt binder quantity is 150 tons or greater, it is sampled, tested and evaluated as a separate lot.

If the bid quantity of asphalt binder is between 85 – 200 tons, the bid quantity is considered as one lot and sampled, tested, and evaluated according to this subsection. Quantities of asphalt binder less than 85 tons will be accepted based on manufacturer's certified test reports and certification of compliance.

Sample asphalt binder at the plant from the supply line in the presence of the Engineer

according to ATM 401. The Engineer will take immediate possession of the samples. Take three samples from each lot, one for acceptance testing, one for Contractor requested retesting, and one held in reserve for referee testing if requested. Meet Subsection 702 requirements for asphalt binder quality.

6. Asphalt Binder Grade Retest. Retest of acceptance test results may be requested provided the quality control requirements of Subsection 401-3.02 are met. Deliver the request in writing to the Engineer within 7 days of receipt of notice of failing test. The original results are discarded and the retest result is used for acceptance. Only one retest per sample is allowed.

If the contractor challenges the result of the retest, the referee sample held by the Engineer will be sent to a mutually agreed upon independent AASHTO accredited laboratory for testing. The original acceptance test result, the retest acceptance test result, and the referee sample test result will be evaluated according to ASTM D3244 to obtain an Assigned Test Value (ATV). The ATV will be used to determine if the asphalt binder conforms to the contract. The Contractor shall pay for the referee sample test if the ATV confirms the asphalt binder does not meet contract requirements.

## Appendix B

### Subdivision Construction Plan

Date \_\_\_\_\_

## SUBDIVISION CONSTRUCTION PLAN

Subdivision Name \_\_\_\_\_

Platting Case File # \_\_\_\_\_

RSA # \_\_\_\_\_

Developer/Petitioner \_\_\_\_\_

Phone # \_\_\_\_\_

email \_\_\_\_\_

Engineer \_\_\_\_\_

Phone # \_\_\_\_\_

email \_\_\_\_\_

Surveyor \_\_\_\_\_

Phone # \_\_\_\_\_

email \_\_\_\_\_

Contractor \_\_\_\_\_

Phone # \_\_\_\_\_

email \_\_\_\_\_

### Required Submittals

Cost Estimate

Drainage Plan

SWPPP (if disturbing more than 1 acre)

\_\_\_\_\_

\_\_\_\_\_

\_\_\_\_\_

\_\_\_\_\_

**THE FOLLOWING IS THE PLAN FOR THE REQUIRED IMPROVEMENTS:**

- 1) The Developer’s Professional Civil Engineer (PE) shall be the spokesperson for implementation and completion of this PLAN.
- 2) The PE shall submit the required data and reports in a timely manner. All submittals must be sent/delivered to the Borough’s Platting Office.
- 3) The PE shall supervise all phases of the PLAN and be the point of contact for all contractor and subcontractor work on the PLAN.
- 4) Any proposed changes to this PLAN must be approved by the Borough’s Public Works Department prior to the changes being made.
- 5) Upon acceptance of all improvements and approval of the Final Report by the Borough’s Public Works Department, a Certificate of Construction Acceptance will be issued to the Developer and the warranty period will begin.

Where will driveway approaches be constructed? \_\_\_\_\_

Will winter construction be performed? \_\_\_\_\_

Is a subdivision agreement anticipated? \_\_\_\_\_

Will paving be performed? \_\_\_\_\_

Will a community water or sewer system be installed? \_\_\_\_\_

Permits to be acquired: \_\_\_\_\_  
\_\_\_\_\_  
\_\_\_\_\_  
\_\_\_\_\_

Types of utilities to be installed: \_\_\_\_\_

Note: If utilities are not installed prior to road construction, the Developer shall coordinate with the utility to either install conduits at the proposed crossing locations or ensure through their Engineer that the road crossings are excavated and backfilled properly. It is strongly encouraged that the road surfacing material be placed AFTER the utilities have been installed.

**Planned Work Schedule**

Clearing and Grubbing	_____
Installation of Utilities	_____
Subbase Construction	_____
Drainage Improvements	_____
Import and Grading top 6"	_____
Property Corners set by PLS	_____

Additional Comments:

AGREEMENT:

It is hereby agreed that the above PLAN is acceptable and will be implemented for the required improvements. It is further agreed that no deviation will be made to the above PLAN without signed acceptance by the Professional Civil Engineer and the Borough Public Works Representative.

---

Developer's Signature

Date

---

Professional Civil Engineer's Signature

Date

---

Surveyor's Signature

Date

---

Contractor's Signature

Date

---

Borough Public Works Representative's Signature

Date